

Vacuum, Inert and Reactive Gas Furnaces up to 3000 °C





Science for Solids

Materialography
Heat Treatment
Elemental Analysis
Milling & Sieving
Particle Analysis

As part of the VERDER Group, the business division VERDER SCIENTIFIC sets standards in the development, manufacture and sales of laboratory and analytical equipment. The instruments are used in the areas of quality control, research and development for sample preparation and analysis of solids.

Leading Heat Technology

Portfolio

With the formation of Carbolite Gero GmbH & Co. KG, customers realizing heat-treatment processes from 30 °C to 3000 °C now have access to a single highly qualified source for equipment. Carbolite Gero instruments work with vacuum, partial pressure, air, controlled pressure, and overpressure environments. The equipment can be used with inert gases such as argon or nitrogen, and also reactive gases such as hydrogen or oxygen.

History

Carbolite Gero has two production facilities. One is located in Sheffield, United Kingdom, where Carbolite has been manufacturing ovens and furnaces up to 1800 °C since 1938. The second facility is located in Neuhausen, Germany, where high temperature Gero furnaces have been produced since 1982. Gero took its name from its two founders – Roland Geiger and Gerd Lamprecht – who initially specialized in crystal growing devices and then, based on their knowledge of these demanding systems, developed furnaces for heat treatment in various atmospheres up to 3000 °C. Over the years Carbolite Gero has established a name for high quality and reliable products. Carbolite Gero is part of the Verder Scientific Division, which includes the other laboratory manufacturing companies Eltra, Retsch and Retsch Technology.

Decades of experience in high temperature technology.

In addition to a wide range of standard products across the entire temperature range, Carbolite Gero is an expert in the development of customized equipment for complex heat treatment processes. To precisely meet customer requirements, Carbolite Gero follows a strict and professional project plan.

The foundation for a good project: Understanding customer requirements. The Carbolite Gero technical staff consists of highly-qualified engineers, physicists and chemists with a strong theoretical background. They are true experts in the wide range of heat treatment applications up to 3000 °C. Their in-depth knowledge of different technological disciplines is key to discussing projects with customers on the same basis as well as coming to a mutual understanding.

Throughout the entire project: A competent and reliable partner. Next to technological know-how, the greatest strength of Carbolite Gero is the high efficiency in project management. Extensive knowledge of manufacturing and process technologies, as well as materials, results in excellent products that are delivered according to customer specifications and on time. The advantage to our customers: Carbolite Gero considers every project a new challenge to develop innovative economical solutions.

The follow-up: Fast and qualified service, worldwide.

Unlike other manufacturers, Carbolite Gero does not consider a project finished after a unit is delivered or installed. Our extensive network of factory-trained field engineers provides after sales support and technical consultations worldwide so that customers are well-equipped for the future.

www.carbolite-gero.com



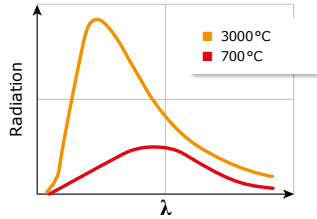

	Model	Page
Introduction		
Physics of Heat		06
Vacuum Technology		08
Furnace Selection Guide		10
Index		82

30 °C - 1300 °C

This temperature range of furnaces is listed in increasing maximum temperature starting with the EBO, which utilizes hot water to heat to 150 °C. The EBO is focused to catalytic debinding processes. All other furnaces are heated by CrFeAl wire and enable a broad application range up to 1300 °C. For each system, one important and popular application is described briefly.



Debinding, Annealing, Soldering and Tube Furnaces		
Debinding Furnace up to 150 °C	EBO	14
Annealing Furnaces up to 1100 °C	GLO	16
Soldering Tube Furnace up to 1050 °C	VL	20
Tube Furnaces up to 1350 °C	FHA	22
Split Tube Furnaces up to 1300 °C	FST	23
Eight-zone Tube Furnace up to 1300 °C	AZ	24

1300 °C - 3000 °C

In this temperature range, tube furnaces or hot wall furnaces use MoSi₂ heating elements for a maximum temperature of 1800 °C. All other furnaces are referred to as cold wall furnaces as they are equipped with a water cooled vessel. A maximum temperature of 3000 °C is possible. For each system, one important and popular application is described briefly.



Tube Furnaces		
Tube Furnaces, Horizontal up to 1800 °C	HTRH	28
Tube Furnaces, Vertical up to 1800 °C	HTRV	30
Split Tube Furnaces, Vertical up to 1700 °C	HTRV-A	31
Hydrogen Tube Furnace up to 1600 °C	HTRH-H ₂	32
Chamber Furnaces		
Chamber Furnaces up to 2200 °C	HTK	34
Chamber Furnaces up to 1800 °C	HTKE	40
Hood Furnaces		
Hood Furnaces up to 2200 °C	HBO	42
Hood Furnaces up to 1800 °C	HB	46
Bottom Loading Furnaces		
Bottom Loading Furnaces up to 2200 °C	HTBL	48
Laboratory Furnaces		
Laboratory Furnaces up to 3000 °C	LHT	52
Application Specific Furnaces		
Bridgman Crystal Growth Furnaces up to 1800 °C	BV-HTRV	56
Partial Pressure Sintering Furnace up to 1450 °C	PDS	58

Page

Special Furnaces and Options

In this chapter, some special furnaces are described. The metal injection molding furnaces include solutions for the whole process chain of debinding and sintering. *SERIE 3000* furnaces are based on the standard LHTG and HTK GR models, including options for pyrolysis and 3000°C operation. At least some solutions for crystal growth as well as some customized heat treatment systems and their unique features for applications are briefly mentioned.



Metal Injection Moulding (MIM) Furnaces

Solutions for Debinding and Sintering 62

Graphitization Furnaces *SERIE 3000*

Chamber and Laboratory Furnaces up to 3000°C 64

Crystal Growth Furnaces

Solutions for Bridgman-Type Crystal Growth 68

Solutions for Stockbarger-Type Crystal Growth 70

Accessories for Crystal Growth 71

Customized Furnaces

Large Reaction Furnace for CERN 72

Laboratory Furnace with Exchangable Heating Cassette 73

Large F-Type Tube Furnace 73

Options

Integrated Intelligence: Measuring and Control Engineering 74

Accessories and Options 76

Accessories and Options for Tube Furnaces 80

Disclaimer

As Carbolite Gero has a policy of continuous product development, improvements and changes will be made during the lifetime of this catalogue. Carbolite Gero reserves the right to amend the specifications at any time and in any particular way without prior notice provided that

the ultimate performance of the equipment is not reduced by such action. If the dimensions or technical specification of a product in this catalogue are critical, it is important that Carbolite Gero is contacted to confirm the details prior to order placement.



Heat is generated by the averaged random movement of molecules, atoms and electrons. For example: temperature in a gas is caused by the Brownian movement of the molecules and atoms the gas consists of. The same is true for a liquid. The thermal movement of the electrons in a solid is the reason why a temperature measurement with thermocouples is possible. The standard thermocouples are from type K, N, S, R, B and C. They consist of wires from different materials, which are welded together at the tip. The highest temperatures up to 3000 °C are controlled by means of measuring the heat radiation with a pyrometer.

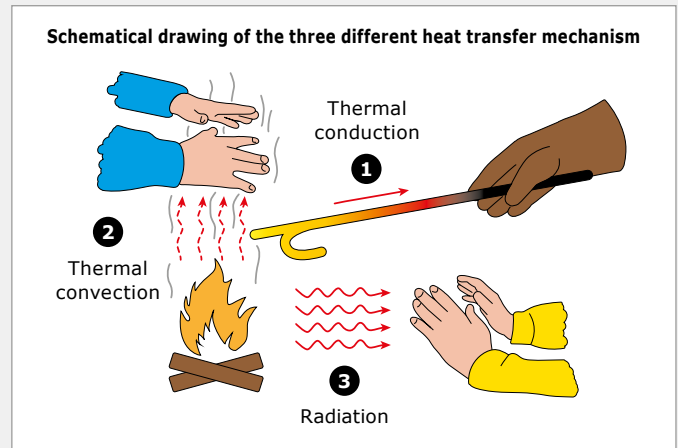

Heat transfer and thermal expansion

There are three primary mechanisms of heat transfer. Two medium dependent ways: convection and conduction as well as one medium independent way, radiation.

1 Thermal conduction heat transfer (medium dependent):

Thermal conduction is the direct transfer of heat (ΔQ) per time (Δt) within and between parts of the furnace through a surface (A). The connection between the parts can be a solid, liquid or a gas. Each material has its heat conductance (κ). This heat transfer works at all temperatures but needs a direct connection (medium) between the heat source and e.g. your sample with a temperature difference ΔT over a length Δx .

$$\frac{\Delta Q}{\Delta t} = -\kappa \cdot A \cdot \frac{\Delta T}{\Delta x}$$

2 Thermal convection heat transfer (medium dependent):

This transfer works by the collective movement/flow of liquids and gases that transport heat between two parts of the furnace. At the higher temperature side, the gas/liquid gets hot, increasing the kinetic energy of the molecules causing diffusion in the colder area. Heat conduction is dominant below 700 °C and needs a medium as heat transport vehicle and does not work in a vacuum environment.

3 Radiation heat transfer (medium independent):

Radiation heat transfer works by electromagnetic waves emitted by hot surfaces. This phenomenon can be observed as a glowing light inside the furnace. Radiant heat will start at 700 °C with red light, 1000 °C with yellow light, and 1500 °C with bright, white light. This heat conduction also works in vacuum and will dominate in atmosphere above 700 °C. There is no direct contact (by a medium) of the heat source and your

sample. This makes radiation heating medium independent. The radiation power (P) of a surface (A), with the temperature (T) is described by the famous Planck equation. $\sigma = 5.7 \cdot 10^{-8} \frac{\text{W}}{\text{m}^2\text{K}^4}$ is the Planck constant of the black body radiation.

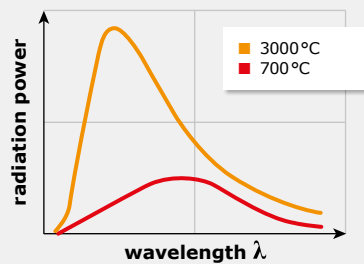

$$P = \sigma AT^4$$

4 Thermal expansion:

Each material has its specific thermal expansion coefficient (α). When the material is heated up (ΔT) to a certain temperature, its dimensions are expanded (Δl).

Ceramic tubes suffer from high thermal stress in tube furnaces where the temperature is rapidly reduced. As a result, ceramic tubes with large diameters are not recommended as the tube is susceptible to break.

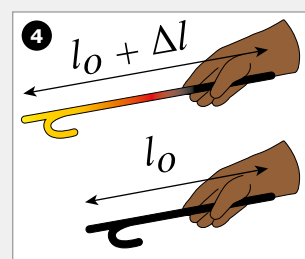

$$\frac{\Delta l}{l_0} = \alpha \Delta T$$

Some design and insulation principles

In reality, all three heat transfer mechanisms are present at the same time. As a result, time consuming calculations and simulations are needed to design a furnace with outstanding temperature homogeneity. Carbolite Gero has accumulated decades of engineering experience creating exceptional heat treatment systems. Some important design principles are:

Multi-zone:

Multi-zone tube furnaces are capable of compensating the temperature drop towards the ends of a tube. Three and eight zone furnaces are available.

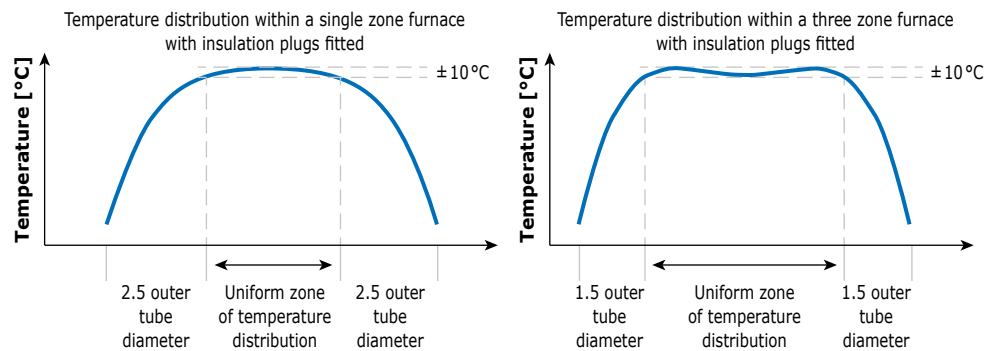

Retort:

A closed retort is utilized to completely surround the sample specimen for operation under modified atmospheres and to improve the temperature homogeneity. For example, the retort is constructed with a gas outlet for debinding applications.



Graphite retort with a gas outlet tube

Intelligent design:

For optimal temperature homogeneity and distribution inside the furnace, a highly symmetric design is crucial. If a gas flow is required, the gas is preheated before flowing into the chamber. A gas ventilation system with a sophisticated gas guiding design are provided for furnaces operating in the low temperature range.



Ventilator for gas circulation

Radiation shields:

Metallic shields are utilized in the metallic furnaces to constantly reflect the heat inwards toward the sample specimen and provide insulation to the water cooled vessel. The vessel design, radiation shields, and heating elements must be highly symmetrical for optimal temperature homogeneity.

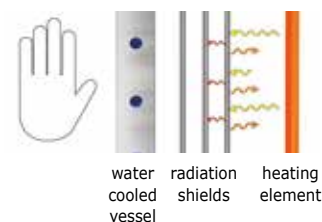

water cooled vessel radiation shields heating element

High-grade insulation:

The thermal conductivity (κ) of graphite felt and ceramic fibre insulation is very low making them excellent materials for furnace insulation. The thickness and quality of the insulation materials are carefully and specifically chosen per the maximum operating temperature of the furnace.

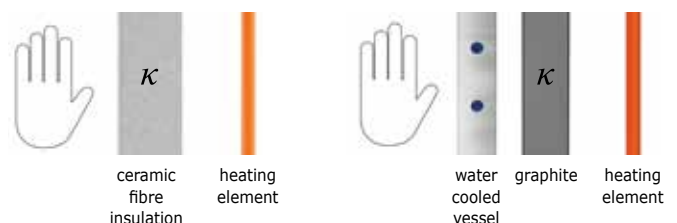

ceramic fibre insulation heating element water cooled vessel graphite heating element

Nowadays, many heat treatment processes are carried out in vacuum environment. For vacuum metallurgy, annealing, crystal growing, soldering and brazing and many more applications, vacuum technology must be combined with heat treatment. For this purpose, the samples have to be surrounded by a sealed device, such as a sealed working tube, a sealed retort or a sealed water cooled vessel. The most important advantage of the evacuation is the reduction of the Oxygen level to avoid the sample from oxidation. Besides, for heat treatment processes with a temperature above 1800°C, the Oxygen level has to be reduced to prevent the heating elements and the insulation material itself from oxidation. Air consists of a mixture of different gases, containing Nitrogen, Oxygen, Argon and some other gases in a very low percentage.

Having air at room temperature at atmospheric pressure, approximately 21% of the particles are Oxygen molecules. When the furnace is operated under a vacuum, the number of Oxygen molecules inside the furnace is significantly reduced, which results in lower pressure. The technology to generate these vacuum levels is dependent on the vacuum range required. The distinctions of the vacuum ranges are defined in table 1. Furnace operation under a vacuum allows the highest purity of gases to be maintained, which is another advantage when inert or reactive gases are used in the process.

The entire mixture of gases have a random movement and collide with the walls of the furnace resulting in a force (F) that is introduced to the surface (A) that yields a certain pressure (P). Temperature and force are directly proportional, and consequently, as temperature increases, the force increases resulting in an increase in pressure. The Kelvin temperature scale provides further illustration of this principle, as at 0 K (-273°C), the pressure is zero as the particles cease to move.

At atmospheric pressure and room temperature, an equivalent force is present on both the internal and external walls of the furnace. When a vacuum is applied to the furnace, equivalent pressure on the vessel wall is no longer true as the external wall of the furnace has significant force against it. Consequently, the work tube, sealed retort, or furnace vessel must be adequately calculated and constructed to withstand required operating vacuum levels.

$$p := \frac{F}{A}$$

The SI standard unit for the pressure is the so called Pascal. $1 \text{ Pa} = 1 \frac{\text{N}}{\text{m}^2}$. Nowadays it is more convenient to use mbar as the unit for vacuum. This nomenclature will be maintained. (1 mbar = 100 Pa).

Vacuum ranges

Table 1

	ultra high vacuum	high vacuum	fine vacuum	rough vacuum
pressure [mbar]	< 10 ⁻⁷	10 ⁻⁷ - 10 ⁻³	10 ⁻³ - 1	1 - 1000
n [cm ⁻³]	< 10 ⁹	10 ⁹ - 10 ¹³	10 ¹³ - 10 ¹⁶	10 ¹⁶ - 10 ¹⁹

Table 1 illustrates the characteristics of the four different vacuum levels and is not arbitrary as the technology needed to generate a required vacuum level is dependent on the vacuum range.

The most common pumps that can be attached to the high temperature furnaces are shown on page 9 in relation to their operating ranges. A rotary vane pump is used to generate a rough vacuum. A double stage rotary vane pump can generate a rough vacuum and nearly achieve the fine vacuum range. For operation in the fine vacuum range, the rotary vane pump must be used in tandem with a roots pump. Turbomolecular or oil diffusion pumps must be used to operate in the high vacuum range.

Pressure environment

The heat treatment can be carried out in different atmospheres. Four different environments are distinguished:

- 1. Vacuum:** Pumps are configured and installed to achieve the working pressure required. (see Figure 1)
- 2. Partial pressure:** The furnace is purged with a gas flow, and with the use of a pump, the pressure inside the furnace can be adjusted. As a result, a defined gas flow below atmospheric pressure is possible.
- 3. Controlled pressure:** The furnace is purged with gas, and a slight overpressure is generated that can be relieved with a valve.
- 4. Overpressure:** Gas is guided into the furnace until a defined overpressure up to 100 bar is generated.

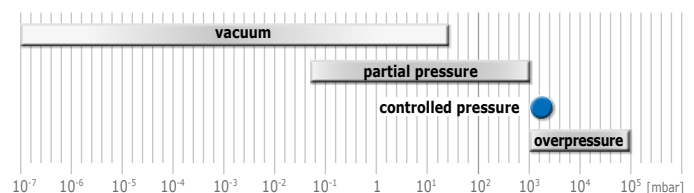

Vacuum pumps

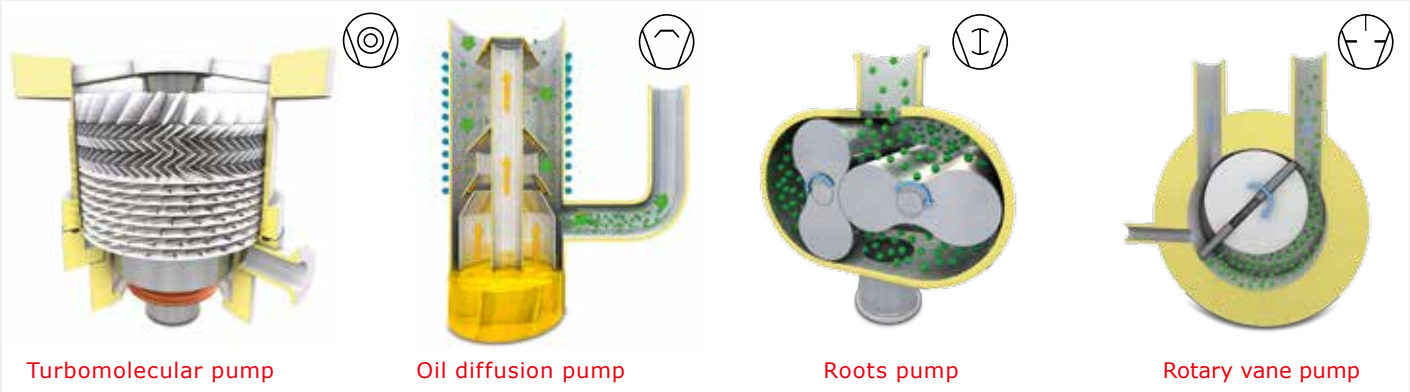

The turbomolecular pump consists of stators between several high speed rotors. The rotational speed is more than 10000 turns per minute. At these speeds, the rotor is now in the range of the particle velocity enabling gas to be pushed through the pump. When combined with a pre-vacuum pump, the achievable vacuum level is in the high vacuum range or better. Turbomolecular pumps are the most convenient and frequently used pumps for high and ultra-high vacuum operation. Very high atmospheric purity of the furnace chamber is achieved as the pump easily removes heavy, slow particles, such as hydrocarbons, and maintains the high speeds needed to evacuate light, fast moving particles.

Oil diffusion pumps do not contain any moving parts. The operating principle is based on the fast, downward movement of oil steam to remove the air molecules to the pre-vacuum pump. At the bottom of the pump, oil is heated and evaporated to generate the oil steam needed for this process. The generated oil steam travels upwards and is guided through spray valves downward again. A high vacuum can be achieved with a very high pumping speed; however, a few oil molecules will remain in the furnace chamber.

The roots pump is suited for heat treatment in the fine vacuum range. The vacuum chamber is not greased and consists of two plugs that rotate against each other. The plugs are fabricated very precisely with nearly no gap between the plugs themselves and vacuum chamber walls. A pre-vacuum pump is required for use of the roots pump.

The rotary vane pump is a pre-vacuum pump and is the most frequently utilized pump. Single or double stage rotary pumps are available. The pump is used for direct evacuation of atmospheric pressure with a rotating speed of approximately 1500 turns per minute via a radial, movable plug. The vacuum chamber of the pump is greased with oil. A rough vacuum is achievable, and a fine vacuum can nearly be achieved by the double stage pump.

The most common vacuum pumps are listed above. Upon request, special pumping systems can be configured. For example, if reactive gases are to be used, pumps without lubrication or special lubrication are sourced. For special applications, membrane pumps, cryo-pumps, ion getter pumps, etc., can be supplied.

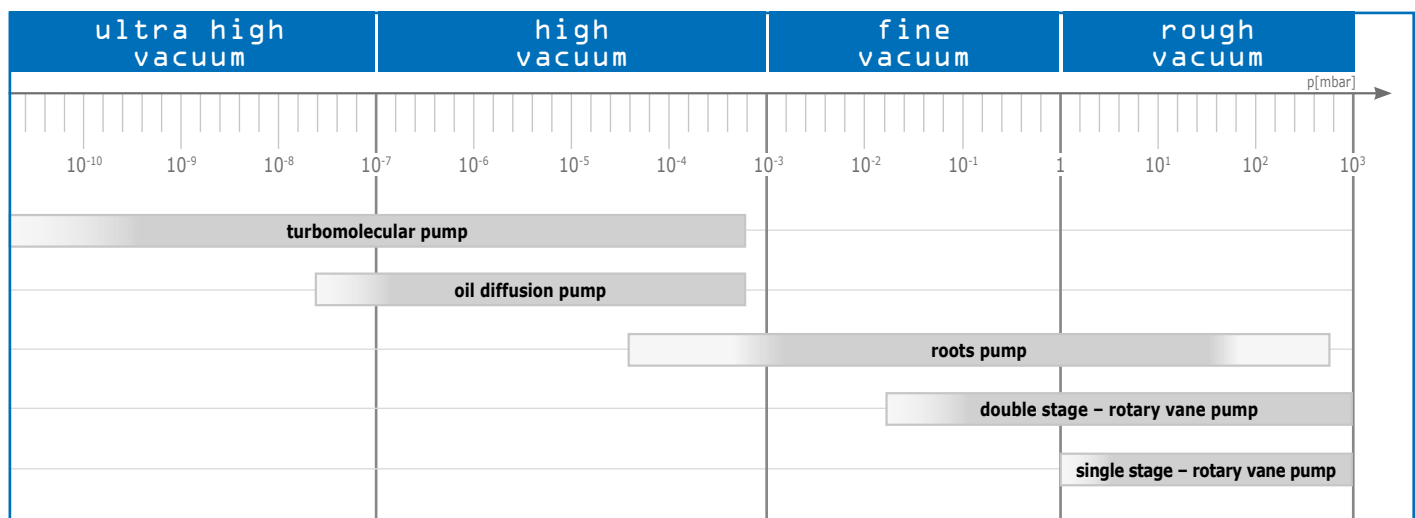

Figure 1

Temperature

For heat treatment processes, the required operating temperature must first be established. By design, a resistance heated furnace is limited to its maximum temperature. Three main different insulating principles exist: Ceramic fibre insulation, metallic (Mo and W) radiation shields and graphite felt insulation. CrFeAl wires or MoSi₂ U-shaped elements are two possible heating elements. Both ceramic fibre and graphite felt insulation have low heat conductance and are outstanding insulation materials. Both heating elements need an oxidizing atmosphere during heat treatment to build up a protective layer. The heating elements consisting of molybdenum (Mo) or tungsten (W) are insulated by radiation shields made from the same material. The multi-layered shields reflect the heat radiation and insulate the furnace. High vacuum operation is possible due to the low vapor pressure of the metallic material. The heating elements made from graphite are insulated by graphite felt. An oxidizing atmosphere is not permitted. Due to the vapor pressure of graphite, carbon in the atmosphere cannot be avoided during heat treatment. The different heating principles enable different maximum temperature ranges that are divided into two segments. The first segment is the 30 °C to 1300 °C, and the second is from 1300 °C to 3000 °C.

Atmosphere

The next important issue is the determination of the atmosphere in which the heat treatment process is carried out. Figure 2 provides a basic overview of the various atmospheres in relation to the temperature range and heating elements used. The ideal heating elements are provided in conjunction with the specified atmosphere. A general rule of thumb holds that all standard gases and atmospheres can be used up to 1800 °C, such as air, Oxygen, Nitrogen, Argon, Hydrogen, and all vacuum levels. If the required temperature is between 1800 °C and 2200 °C, heat treatment in Nitrogen, Argon, Hydrogen and all vacuum levels are possible. If the required temperature is between 2200 °C and 3000 °C, heat treatment is possible in Argon.

Conclusion

Once the required temperature and atmosphere for the heat treatment process is known, the heating principle can be derived from Figure 2. The heating principles are implemented in a variety of different furnaces. The final decision for a furnace depends on further aspects like the usable volume, the loading principle, etc.

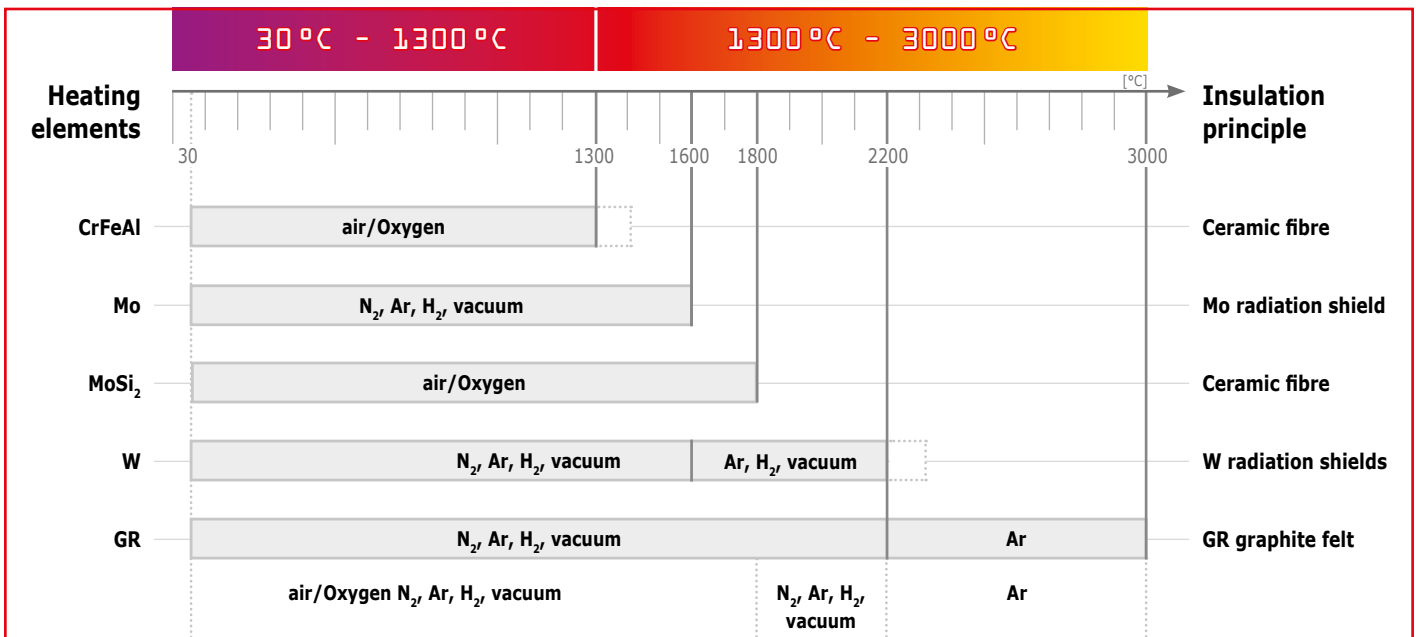





Figure 2: Selection guide

Application matrix

-  specially engineered for it
-  suited
-  limited suitability
- not suited

Debinding, Annealing, Soldering & Tube Furnaces

	Model	Heating principle	Page
Debinding Furnace up to 150 °C	EBO	water	14-15
Annealing Furnaces up to 1100 °C	GLO	CrFeAl	16-19
Soldering Tube Furnace up to 1050 °C	VL	CrFeAl	20-21
Tube Furnaces up to 1350 °C	FHA	CrFeAl	22
Split Tube Furnaces up to 1300 °C	FST	CrFeAl	23
Eight-zones Tube Furnaces up to 1300 °C	AZ	CrFeAl	24-25

Tube Furnaces

Tube Furnaces, Horizontal up to 1800 °C	HTRH	MoSi ₂	28-29
Tube Furnaces, Vertical up to 1800 °C	HTRV	MoSi ₂	30
Split Tube Furnaces, Vertical up to 1700 °C	HTRV-A	MoSi ₂	31
Hydrogen Tube Furnace up to 1600 °C	HTRH-H ₂	MoSi ₂	32-33

Chamber Furnaces

Chamber Furnaces, metal insulation up to 1600 °C / 2200 °C	HTK MO / HTK W	Mo / W	34-39
Chamber Furnaces, graphite insulation up to 2200 °C	HTK GR	GR	34-39
Chamber Furnaces, ceramic fibre insulation up to 1800 °C	HTK KE	CrFeAl or MoSi ₂	34-39
Chamber Furnaces, ceramic fibre insulation, non-vacuum tight up to 1800 °C	HTKE	MoSi ₂	40-41

Hood Furnaces

Hood Furnaces, metal insulation up to 1600 °C / 2200 °C	HBO MO / HBO W	Mo / W	42-45
Hood Furnaces, ceramic fibre insulation up to 1800 °C	HB	CrFeAl or MoSi ₂	46-47

Bottom Loading Furnaces

Bottom Loading Furnaces, metal insulation up to 1600 °C / 2200 °C	HTBL MO / HTBL W	Mo / W	48-51
Bottom Loading Furnaces, graphite insulation up to 2200 °C	HTBL GR	GR	48-51

Laboratory Furnaces

Laboratory Furnaces, metal insulation up to 1600 °C / 2200 °C	LHTM / LHTW	Mo / W	52-55
Laboratory Furnaces, graphite insulation up to 3000 °C	LHTG	GR	52-55

Application Specific Furnaces

Bridgman Crystal Growth Furnaces up to 1800 °C	BV-HTRV	MoSi ₂	56-57
Partial Pressure Sintering Furnace up to 1450 °C	PDS	Mo	58-59

Application																
Hardening	Annealing	Glowing	Tempering	Soldering/Brazing	Degassing	Pyrolysis	Siliconization	Carbonization	Rapid prototyping	Sintering	Debinding	Synthesis	Sublimation	Drying	Crystal growth	MIM

-	-	-	-	-	-	-	-	-	-	-	○	-	-	-	-	○
○	○	○	○	○	○	-	○	○	○	○	○	○	○	○	○	-
○	○	○	○	○	○	-	-	-	○	○	-	○	○	○	-	-
○	○	○	○	○	○	○	-	○	○	○	○	○	○	○	○	○
○	○	○	○	-	○	○	-	○	○	○	○	○	○	○	○	○
○	-	○	○	-	○	○	-	○	○	○	○	○	○	○	○	○

-	-	○	○	-	○	○	-	○	○	○	○	○	○	○	○	○
○	○	○	○	-	○	○	-	○	○	○	○	○	○	○	○	○
○	○	○	○	-	○	○	-	○	○	○	○	○	○	○	○	○
-	-	○	○	○	○	○	-	○	○	○	○	-	○	○	○	○

-	-	○	○	○	○	○	-	○	○	○	○	-	○	○	○	○
-	-	○	○	○	○	○	○	○	○	○	○	-	○	○	○	○
○	○	○	○	-	-	○	-	-	○	○	○	-	○	○	-	-
○	○	○	○	-	-	○	-	-	○	○	○	-	○	○	-	-

-	-	○	○	○	○	○	-	-	○	○	○	-	○	○	○	○
○	○	○	○	-	-	○	-	-	○	○	○	-	○	○	-	-

-	-	○	○	○	○	-	-	○	○	○	○	-	-	○	○	○
-	-	○	○	○	○	○	○	○	○	○	○	-	-	○	○	○

-	-	○	○	○	○	-	-	○	○	○	○	-	○	○	○	○
-	-	○	○	○	○	○	○	○	○	○	○	-	-	○	○	○

-	-	-	○	○	○	-	-	○	-	○	-	○	-	-	○	-
○	○	○	○	○	○	○	-	-	○	○	○	○	○	○	-	○

This temperature range of furnaces is listed in increasing maximum temperature starting with the EBO, which utilizes hot water to heat to 150°C. All other furnaces are heated by CrFeAl wire and enable a broad application range up to 1300°C. For each system, one important and popular application is described briefly.

30 °C - 1300 °C

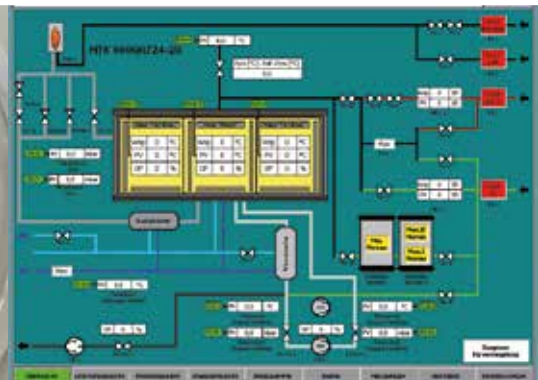

Temperature Range 30 °C – 1300 °C	Models	Page
Debinding Furnace up to 150 °C	EBO	14
Annealing Furnaces up to 1100 °C	GLO	16
Soldering Tube Furnace up to 1050 °C	VL	20
Tube Furnaces up to 1350 °C	FHA	22
Split Tube Furnaces up to 1300 °C	FST	23
Eight-zone Tube Furnace up to 1300 °C	AZ	24



Furnace for catalytic debinding

Metal injection moulding (MIM) and Ceramic injection moulding (CIM) is an expanding modern manufacturing technology. The MIM and CIM manufacturing processes are comprised of 4 steps: compounding raw material into feedstock, moulding feedstock to the desired shape creating a green part, debinding, and sintering. Debinding is the most demanding operation in this process. The debinding of Catamold® feedstock is performed catalytically with nitric acid. This process demands precise control of both the temperature profile and gas pressures.

The EBO is specially engineered to handle the stringent requirements that come with catalytic debinding. The EBO is an ideal solution for binder removal from mouldings made from BASF Catamold® Feedstock. The usable volume of the EBO is 120 litres and the rectangular usable space is 400 mm x 400 mm x 700 mm.

The debinding process begins with a Nitrogen purge in order to reduce the Oxygen content in the furnace. Once the ideal process temperature is achieved, gaseous nitric acid is purged into the furnace at a fixed rate. The Nitrogen gas flow must be maintained higher than the nitric acid gas flow in order to prevent an explosive mixture from forming inside the system. The binder is removed from the green parts starting from the surface to the interior of the moulding as a chemical reaction occurs in the acidic, vapor environment. Debinding rates vary with the particle sizes of the metal powder and are generally between 1–4 mm/h. The polymer binder transitions directly from the green part to the nitric acid once a temperature of 120°C is achieved and yields formaldehyde as a by-product. Formaldehyde can be detected by monitoring the temperature of the EBO's afterburner. When formaldehyde production has ended, binder removal is complete. Once the EBO has detected the binder removal is complete, the acid vapor environment is purged with Nitrogen indicating that the debinding step is complete, and the green parts can be transferred to a sintering furnace.

The operator may choose between a fixed debinding process time and a fully automatic, self-detecting debinding program. The automatic adjustment is able to detect the end of the debinding process and terminate the cycle. CIM applications are limited to a sample wall thickness of approximately 4–5 mm. The furnace is provided with safety interlocks to guarantee operational safety. Operation and visualization of the process is provided by means of a touch panel interface.



EBO 120/1.5: Debinding furnace with a usable volume of 120 l up to 150°C at most. The required working temperature is 120°C. Nitric acid is evaporated, mixed with Nitrogen and purged into the furnace for catalytic debinding.

Advantages

- Water heated vessel up to 150°C
- Dosing and circulation of nitric acid and Nitrogen
- Debinding degree controlled
- Certified safety management

Typical applications

Catalytic debinding of BASF feedstock for MIM and CIM

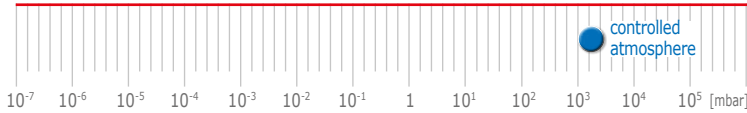

EBO – Debinding Furnace up to 150°C

Technical details

The double walled vessel of the EBO utilizes a water heating system up to 150°C. At low temperatures, the EBO provides exceptional temperature uniformity. In addition, a ventilator is also installed at the rear of the furnace. The ventilator creates gas circulation through the furnace to further improve uniformity. Evaporated nitric acid is uniformly distributed over the furnace and samples in order to completely expose green parts during debinding. The gas is preheated by guiding it along the heated vessel and pulled into the furnace chamber via a fan to flow over the samples for the debinding process. The EBO's front door is automatically locked to prevent opening during the debinding process. A dual stage gas afterburner is installed to combust all by-products generated during the debinding process. The afterburner's temperature is monitored to detect the end of the debinding process during automatic operation.

View inside

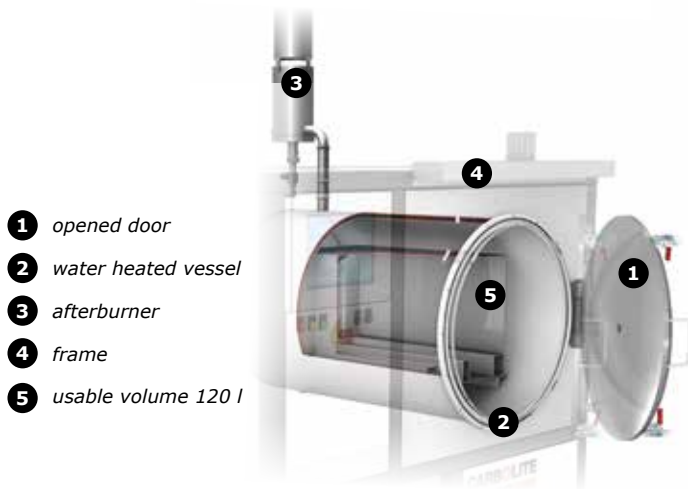

Technical data

MIM/CIM
debinding furnace

Model
EBO 120/1.5

External dimensions

H x W x D with burner [mm]	2150 x 1750 x 1850
-----------------------------------	--------------------

Transport weight

Complete system [kg]	1200
-----------------------------	------

Usable space

Volume [l]	120
Ø x D [mm]	700 x 750

Thermal values

T_{max} [°C]	150
-----------------------------	-----

Connecting values

Power [kW]	15
Voltage [V]	400 (3P)
Current [A]	3 x 63

Gas supply

Process gas Nitrogen [l/h]	300-3000
Combustion device, propane or natural gas [l/h]	270
Nitric acid [ml/h]	30-180

Application Example

Debinding of shaped "green parts"

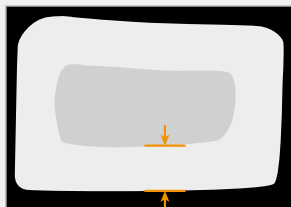

The EBO is a furnace specially designed for the debinding of shaped "green parts" based on the BASF Catamold® feedstock. A broad range of feedstocks is available including mixtures containing low-alloyed steels, stainless steels, special titanium steels, heat resistant steels, soft magnetic material, and oxide ceramics. All feedstocks can be processed in the EBO for the debinding process. The EBO is an ideal solution for the catalytic debinding process with outstanding temperature uniformity and a special gas guidance system that ensures great precision and reproducibility.

The marked part is already catalytically debinded.

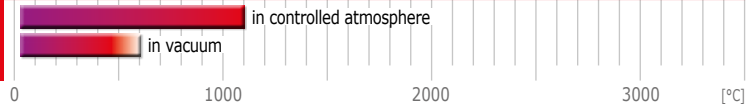

Annealing furnaces

The GLO features a vacuum tight retort with highly symmetric positioning of the heating elements. The heating elements are CrFeAl, also known as APM, and are embedded in the ceramic fibre insulation.

The GLO is often equipped with a vacuum pumping system to reduce the Oxygen levels prior to heat treatment. To ensure the lowest possible contamination levels, several cycles of vacuum and Nitrogen purging occur to create a pure atmosphere in the retort. Vacuum assisted cycling is far superior compared to simply flowing Nitrogen through the retort as the process creates a pure atmosphere faster and requires less Nitrogen. After Oxygen levels have been reduced, heat treatment begins under an inert atmosphere with a slight overpressure. The highest possible temperature of the GLO is 1100°C for heat treatment with an atmosphere. The front door of the cylindrical retort can be heated if required. At the water cooled front door, the gas is purged inside the GLO. It is preheated by the radiation shields, which are inserted at the front. The GLO is provided with a rear port for the expulsion of any gaseous by-products generated during the process. The GLO can be operated manually or with the use of an automated system.

The GLO furnace is available in three different sizes of 40, 75 and 120 litres. The retort is manufactured with temperature resistant steel alloy (1.4841). Other materials are available on request.

The furnace may be operated with reactive gases such as Hydrogen, which requires appropriate safety technology. The Hydrogen safety system includes an automatic operating system with a Nitrogen flooding tank to detect and purge the system should any malfunctions be detected. All devices are SIL2 certified.

The furnaces have a compact, space saving design. The debinding package allows for debinding or pyrolysis processes to be carried out. Virtually no condensation occurs as the unit is equipped with an afterburner and heated gas outlet for strong outgassing applications.

The GLO can be equipped with a fast cooling system. The retort can be air cooled from the outside or purged with cold, inert gas.



GLO 40/11: Annealing furnace with a usable volume of 40 l up to 1100°C under atmospheric pressure.

Advantages

- Precisely controlled atmosphere with highest possible purity
- Sealed retort for highest vacuum possible
- Fast heat up and cool down options upon request
- Hydrogen partial pressure operation upon request
- Afterburner
- Certified safety management for flammable and toxic gases
- Fully automatic operation or manual operation
- Data recording for quality management

Typical applications

Annealing, hardening, glowing, tempering, degassing, pyrolysis, thermal debinding prior to sintering, drying

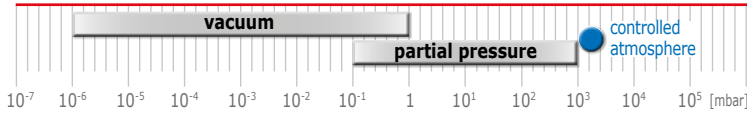

Technical details

The maximum temperature of the GLO is 1100 °C. In this temperature range, heat is transmitted via a high amount of heat convection and conduction. To ensure excellent temperature uniformity, the GLO is equipped with a gas circulation system by means of a ventilator located at the rear of the furnace, which ensures that the sample is surrounded by uniform inert gas at all times. The sample specimen is placed on an engineered, horizontal charging rack with the incoming gases guided over the sample. Any gaseous by-products generated are immediately flushed out of the furnace. A probe thermocouple is positioned at the rear of the furnace and in close proximity to the samples. The probe thermocouple serves as the control thermocouple for the two heating zones of the GLO, and simultaneously, monitors the temperature directly at the sample. The heating elements are located outside of the retort. An over-temperature thermocouple is used for unattended operation. Further thermocouple probes can be integrated into the retort upon request.

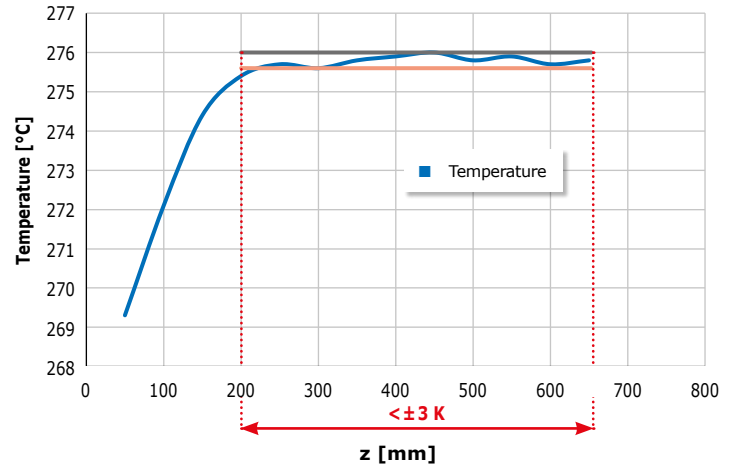

Temperature uniformity of the GLO

The graph shows the temperature of the empty GLO 75/09 along the symmetry axis. The evaluation of the temperature uniformity between 200 mm and 650 mm yields a maximum temperature deviation, which is even better than $\pm 3\text{ K}$. This uniformity is achieved by symmetric arrangement of the heating elements around the retort.

View inside



Retort with inserted charging rack



Zoom inside: Charging rack inside the retort

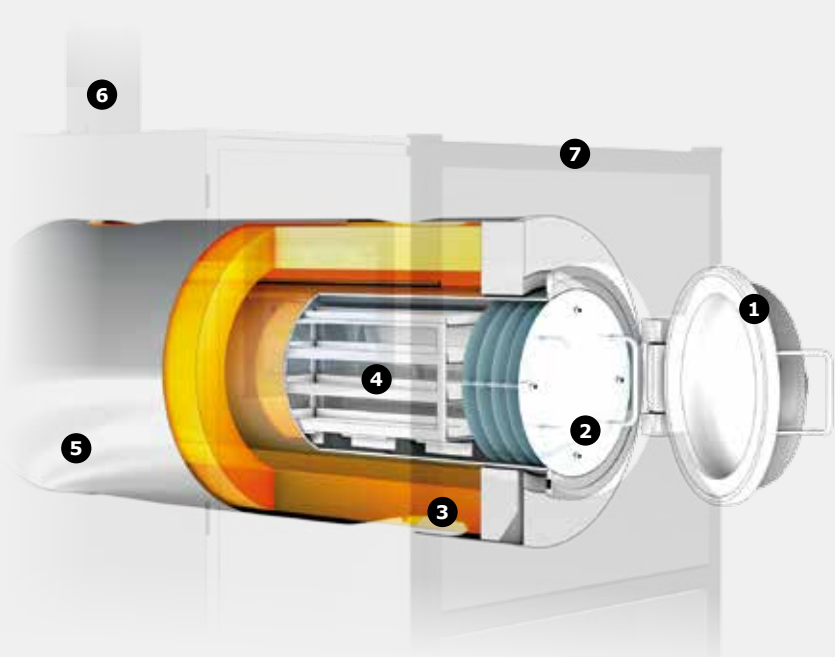

- 1 opened door
- 2 radiation shields
- 3 ceramic fibre insulation and heating elements
- 4 charging rack
- 5 thin metallic surrounding
- 6 afterburner
- 7 frame

GLO – Annealing Furnaces up to 1100°C

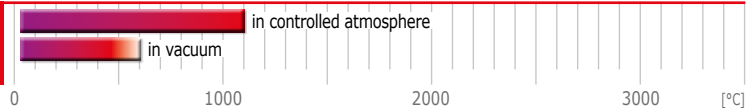

Options

GLO models are available with manual controls or equipped with an automated operating system. Manually controlled systems are available only if the application does not use any reactive gases. If reactive gases are to be used, the system must be equipped with an automated operating system and all relevant safety provisions (SIL2).

Vacuum System:

The GLO can be equipped with a pre-vacuum pump, roots pump, or turbomolecular pump. The use of a pre-pump is more common as heat treatment under vacuum is limited to 600°C (higher temperatures under vacuum available upon request).

Single or double stage rotary vane pumps with a pumping speed up to 20 m³ per hour are commonly used to reduce the oxygen level, prior to heat treatment, by several evacuation and flooding cycles. Higher pumping speeds can be achieved upon request.

Software:

Manual furnaces are operated by Eurotherm controllers in combination with the KP 300 panel. Valves and pumps are operated by simple push buttons on the controller panel. For data logging purposes, iTools software and PC connectivity are available.

- Eurotherm 3508: 10 different storable programs with 500 different segments.
- Eurotherm 3508: 50 different storable programs with 500 different segments
- RS 232/485
- iTools OPTION
- Over-temperature protection option (recommended for continuous and unattended use)
- Remote control

TP 1900 software or WinCC are available for automated operating systems. Both interfaces display the operational data by utilizing a touch panel interface for an intuitive, user-friendly control system. The WinCC system features more operational functions and programming for increased versatility. Both software systems generate csv file for evaluation purposes.

Siemens control unit:

- TP 1900: 20 unique heat programs with 25 different segments can be programmed and stored.
- WinCC: 50 unique heat programs with 30 different segments can be programmed and stored.

Reaction gas equipment:

Hydrogen can be used safely in concentrations that do not exceed 4%. Systems that will exceed 4% concentration of Hydrogen must be equipped with a gas safety system. The gas outlet can also be heated to prevent possible condensation. The GLO can be outfitted to supply more than one inert gas upon request.

- Reaction gas equipment
- Safety package for combustible gases
- Debinding unit with active flame for combustion
- More than one inert gas

Water cooling:

If on-site water cooling is unavailable, a cooling system may be ordered. The cooling power will be designed to meet the requirements of the furnace and on-site power availability.

- Water cooling system: Chiller

VGLO 125/09 or VGLO 125/11:
Vertically mounted GLO with a usable volume of 125 l up to 900°C or 1100°C respectively. The functional principle is the same as for the GLO.



Application Example

Pyrolysis of wood based fibres for high performance materials



Silicon carbide ceramics are high performance modern materials. A typical production method is to infiltrate carbon with Silicon. Carbon is often made by the pyrolysis of wood. Wood is a sustainable material and cost effective to shape. Wood based fibres are mixed with a resin in a predefined ratio. The part is shaped, and then pyrolysis is carried out on the compound. Pyrolysis takes place in a Nitrogen atmosphere (99.995% purity). The process continues by heating at 1 Kelvin per minute up to 500°C and 10 Kelvin per minute up to 1100°C. Pyrolysis starts with the decomposition of wood with the separation of absorbed H₂O up to 150°C and follows up with disintegration of the biopolymer. Finally, all polymeric wood constituents are depolymerized and transformed into carbon. The GLO is well suited for this pyrolysis application.

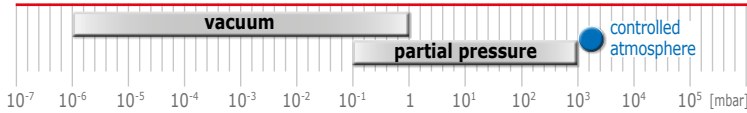

Technical data



Model

GLO Annealing Furnaces, Retort made of 1.4841, Inconel or APM

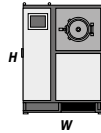

GLO 40/11-1G

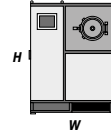

GLO 75/11-1G

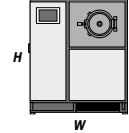

GLO 120/11-1G

External dimensions

H x W x D [mm]	1900 x 1400 x 1800	2000 x 1600 x 1800	2100 x 1800 x 2000
-----------------------	--------------------	--------------------	--------------------

Transport weight

Complete system [kg]	1200	1500	2000
-----------------------------	------	------	------

Usable space

Volume [l]	40	75	120
Ø x D [mm]	300 x 600	400 x 600	500 x 700

Thermal values

T_{max} vacuum [°C]	600 (1.4841)	600 (1.4841)	600 (1.4841)
T_{max} atmospheric pressure [°C]	600 / 900 / 1100	600 / 900 / 1100	600 / 900 / 1100
ΔT, between 300 °C and 1100 °C [K] (according to DIN 17052)	±3	±3	±5
Max. heat-up rate [K/min]	10	10	10
Cooling time [h]	7-9	7-9	8-10

Connecting values

Power [kW]	25	40	60
Voltage [V]	400 (3P)	400 (3P)	400 (3P)
Current [A]	3 x 63	3 x 110	3 x 180
Series fuse [A]	3 x 80	3 x 160	3 x 200

Vacuum (option)

Leakage rate (clean, cold and empty) [mbar l/s]	< 5 x 10 ⁻³		
Vacuum range depending on the pumping unit	rough, fine or high vacuum		

Cooling water required

Flow [l/min]	1-3	1-3	1-3
Max. inlet temperature [°C]	23	23	23

Gas supply

Nitrogen or Argon flow, others on request [l/h]	200-2000	200-2000	200-2000
--	----------	----------	----------

Controller

Manual operation	Eurotherm with KP 300 panel		
Automatic operation	Siemens		

**VL – Soldering Tube Furnace
up to 1050°C**

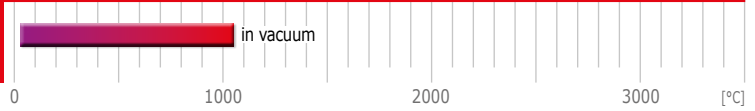

**Automatic tube furnace for
applications in atmospheres
with highest possible purity**

The vertical tube furnace (VL) is suitable for generating the lowest achievable operation pressures. Due to this vacuum capability, the highest purity gas atmosphere can be achieved.

The VL is a vertically mounted tube furnace with automated controls for the sample loading and unloading, in addition to, raising and lowering the furnace hearth over the integrated quartz tube containing the sample material. The quartz tube is connected to the furnace, so in loading the furnace, the quartz tube and furnace hearth are raised upwards to freely access the sample area. After the sample is loaded, the quartz tube and furnace hearth are lowered and locked into position for the heat treatment process where high vacuum operation is achievable. The furnace hearth can also be raised upward and away from the quartz tube after the heating process for fast cooling of the specimen in vacuum, air, or in an inert gas atmosphere.

The furnace utilizes CrFeAl wire elements and ceramic fibre insulation. The temperature is monitored and controlled via thermocouples. The maximum temperature is limited by the quartz tube and can be as high as 1050°C under vacuum operation. The quartz tube is closed at the top section with the bottom section open where samples are loaded and vacuum systems can be attached by a polymer sealing. The usable space has a diameter of 180 mm and a height of 300 mm providing an approximate volume of 2 l that can be rapidly evacuated. Additionally, the quartz tube provides a very clean operating space. Lastly, the VL offers fast cooling possibilities and a high degree of user accessibility to the furnace.

High vacuum levels of 5×10^{-6} mbar and better are achievable. Gases are controlled by various dosing and controlling devices. The vacuum is provided by different pumping stations depending on the vacuum requirements.



Tube furnace in the upper position. The quartz recipient stays at the bottom and is still connected to the vacuum pumping unit.

VL 180-300/10: Soldering tube furnace with a usable diameter of 180 mm and 300 mm heated length. The maximum temperature under vacuum is 1050°C.

Advantages

- Precisely defined atmosphere with highest possible purity (6 N or better)
- Best possible vacuum
- Designed for rapid heating and cooling
- Certified safety management for flammable and toxic gases
- Fully automatic operation
- Movable quartz recipient
- Data recording for quality management

Typical applications

Annealing, tempering, quenching, soldering, brazing, degassing, pyrolysis, rapid prototyping, sintering, debinding, synthesis, sublimation, drying, MIM, CIM

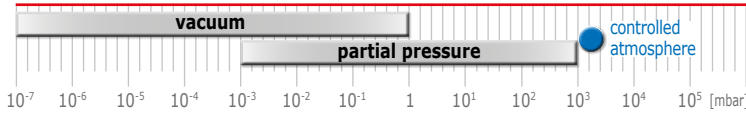

Technical details

The furnace is insulated with ceramic fibre with heating elements of CrFeAl wire. The top of the furnace hearth is closed and sealed with a ceramic fibre plug. The furnace has three heating zones controlled by the operating software to achieve the best possible temperature uniformity. The temperature of the furnace is monitored and controlled by mantle thermocouples in each zone, in addition to, an over-temperature thermocouple. The maximum temperature is limited to 1050°C, which is the maximum possible temperature for the quartz tube under vacuum. The quartz tube is closed at the top end with the bottom end sealed to a flange at the loading plate. Metallic radiation shields are inserted to insulate the heat towards the loading plate. At the loading plate, the pumping unit is attached. Located below the loading plate, a gas guiding tube is attached and positioned such that it is 300 mm above the ground plate to ensure gas flow is from the top to the bottom of the quartz tube. The gas outlet is attached to the vacuum flange. From this vacuum flange, several sample thermocouples can be positioned as required in the quartz tube. The furnace is operated by a fully programmable operating system with a touch panel display for monitoring the process temperature and operating parameters.

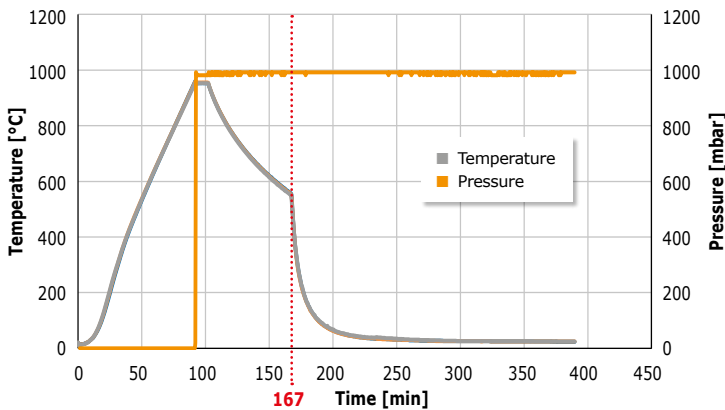

Testing heat cycle: Evacuation down to a working vacuum of 3×10^{-6} mbar, heating up to 950 °C, flooding up to atmospheric pressure and cool down. After 167 minutes, the tube furnace was lifted to the top position. The quartz tube was exposed to an air flow for fast cooling.

Technical data

Vertical Soldering Tube Furnace



Model

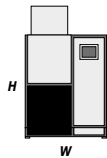

VL 180-300/10-1G

External dimensions

H x W x D [mm]	2300 x 1400 x 1400
-----------------------	--------------------

Usable space

Volume [l]	7.6
Ø x H [mm]	180 x 300

Thermal values

T_{max} vacuum [°C]	1050
ΔT, according to DIN 17052 at a height of 300 mm with a three zone furnace [K]	± 3
Cooling time [min]	30
Control and overtemperature thermocouple	type K

Connecting values

Power [kW]	12
Voltage [V]	400 (3P)
Current [A]	3 x 30
Series fuse [A]	3 x 35

Controller

Manual operation	Eurotherm with KP 300 panel
Automatic operation	Siemens

Cooling water required

Flow [l/min]	30
---------------------	----

Application Example

Soldering and brazing in a high vacuum environment up to 1050 °C



The VL is specially designed for soldering and brazing of small components up to 1050°C. Many electronic components used for satellites, airplanes, radar systems, or laser tubes need to be soldered and brazed in a high vacuum environment. The superior vacuum capability of the VL make it the ideal furnace for these applications. After heat treatment, the furnace is lifted, and the sample can be quickly cooled. The fast cooling capability allows the furnace to be accessible to the user shortly after the heat process concludes. In addition to the excellent vacuum, the tube furnace hearth can be moved while the sample remains stationary in effort to eliminate any vibrational harm to the sample. The furnace hearth movement is controlled automatically. The automated operating software ensures, with its precise data logging, that the process can be controlled, evaluated, and improved. All operational data such as vacuum, temperature, gas flow, etc., are logged at predefined time intervals and is easily exported to a csv file for review and evaluation.

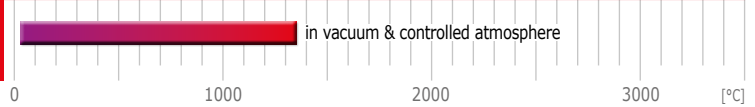

Laboratory tube furnaces

Carbolite Gero standard tube furnaces, type F, can be operated in both vertical and horizontal positions up to 1350°C.

The heating element consists of an uncovered CrFeAl heating coil which is mounted on a ceramic fibre module. The low thermal mass of the ceramic fibre insulation guarantees low energy consumption and allows high heating rates. With its wide range of accessories, the comprehensive type series F provides complete system solutions for ambitious thermal treatment.



FHA 13/80/500: Laboratory tube furnace with heated length of 500 mm up to 1350°C and control module.

Advantages FHA & FST

- Use in horizontal or vertical orientation
- Exceptional long lifetime and temperature stability
- Vacuum equipment available
- Inert and reactive gas equipment available
- High grade thermocouple type S
- Low thermal mass ceramic fibre insulation
- High quality 5 mm APM wire as heating element

Technical details

The rectangular housing is constructed with slots for convection cooling of the outer housing. With insulation made from low thermal mass ceramic fibre material, the heat conduction is reduced to a minimum. Inside the furnace, the heating element is constructed of vacuum formed fibres containing free radiating heating elements that are attached to the insulation by a ceramic holding ridge. When compared to conventional heating methods, the 5 mm thick heating wires are combined with a low voltage, heavy-weight transformer power supply that provides an extraordinary long lifetime of the heating elements and temperature stability. The control thermocouple is a high grade type S thermocouple. Additionally, the tube furnace is available with up to 8 heating zones for the most precise temperature control and uniformity.

For further options see pages 28, 74 and 80

View inside

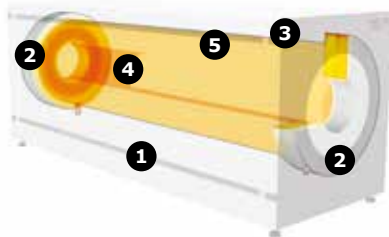

- | | |
|-------------------|-------------------------------|
| ① outer case | ④ heating elements |
| ② end insulation | ⑤ inner insulation (hot face) |
| ③ case insulation | |

Typical applications FHA & FST

(may need further equipment)

Hardening, annealing, tempering, soldering, brazing, degassing, calcination, sintering, synthesis, sublimation, drying, MIM, CIM, miniplants, ageing, catalyst research, pyrolysis, thermocouple calibration, test fuel cells, coating, CVD

Application Example

Aging experiments for material approval for heavy duty applications at high temperatures



In research and development, several new materials are published and used in industrial processes all over the world every year. For some applications, it is important to know the properties, limitations, and long term stability of those materials at high temperatures. For that purpose, the F-Series tube furnaces provide exceptional long term stability for temperatures up to 1350°C. As a result, users can examine the changes in the sample material's physical properties at higher temperatures in relation to time. Such so called aging tests are a standard procedure in order to meet and surpass the strictest specifications to gain technical approval for usage in certain applications, such as reactor pressure vessels or as heat conductors in power plants, where high temperatures stress all materials more than in most other applications.

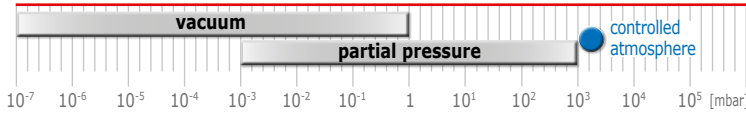

FST – Split Tube Furnaces up to 1300°C

Laboratory split tube furnaces

The Carbolite Gero split tube furnace, FST Series, can be operated in both vertical and horizontal orientations up to 1300°C.

The split tube arrangement of the heating module allows for an easy positioning of the work tube or even whole reactors with multiple adapters. The opening mechanism of the furnace allows faster cooling of the sample as well. The insulation consists of light, multi-layer fibre material.

The split rectangular housing with slots for convection cooling provides a cool outer case like the standard F-Series furnace. A bracket handle is attached to the upper half of the split tube furnace with two quick-action clamps to safely lock the furnace. The two furnace halves are made of vacuum formed fibre modules with heating elements mounted to the insulation by a ceramic holding ridge. A safety door switch protects personnel by switching off the heating elements immediately upon opening the door. This split tube furnace is available with up to 3 heating zones for comprehensive temperature control. Special versions and a comprehensive range of accessories complete the available options.



FST 13/70/500: Laboratory split tube furnace with heated length of 500 mm up to 1300°C.

Additional advantages for split tube furnaces FST

- Large flanges can stay attached to the tube
- Intricately shaped tubes and tube accessory configurations (e.g. reactors with many inlets and outlets) can be placed in the heating zone without disassembly
- For split tube furnaces, we offer robustly shaped ceramic half tubes to protect the heating elements and for sample holding

Technical data

Type series FHA (standard tube furnace) and FST (split tube furnace) both available with one or three heating zones

Model	T _{max} [°C]	Max. outer diameter accessory tube [mm]	Heated length [mm]	Dimensions: External furnace H x W x D [mm]	Furnace weight [kg]	Recommended tube length		Dimensions: Control module H x W x D* [mm]	Control module weight [kg]	Single zone uniform length ± 5°C [mm]	Three zone version available	Power [W]	Power supply
						for use in air [mm]	for use with modified atmosphere [mm]						

Horizontal and Vertical Tube Furnaces (may need further equipment)

FHA 13/32/200	1350	32	200	420 x 400 x 350	25	390	925	480 x 560 x 500	50	100	no	1200	a
FHA 13/32/500	1350	32	500	420 x 700 x 350	30	690	1225	480 x 560 x 500	50	250	yes	2400	a
FHA 13/50/200	1350	50	200	420 x 400 x 350	30	390	925	480 x 560 x 500	50	100	no	1500	a
FHA 13/50/500	1350	50	500	420 x 700 x 350	35	690	1225	480 x 560 x 500	50	250	yes	3000	a
FHA 13/50/750	1350	50	750	420 x 950 x 350	40	940	1475	850 x 560 x 500	60	375	yes	5400	b
FHA 13/80/200	1350	80	200	420 x 400 x 350	35	390	925	480 x 560 x 500	50	100	no	2100	a
FHA 13/80/500	1350	80	500	420 x 700 x 350	40	690	1225	480 x 560 x 500	60	200	yes	5200	b
FHA 13/80/750	1350	80	750	420 x 950 x 350	50	940	1475	850 x 560 x 500	70	375	yes	7800	c
FHA 13/80/1000	1350	80	1000	420 x 1200 x 350	80	1190	1725	850 x 560 x 500	90	500	yes	10400	c
FHA 13/110/500	1350	110	500	590 x 700 x 520	55	690	1225	850 x 560 x 500	70	250	yes	7800	c
FHA 13/110/750	1350	110	750	590 x 950 x 520	70	940	1475	850 x 560 x 500	90	375	yes	11400	c
FHA 13/110/1000	1350	110	1000	590 x 1200 x 520	100	1190	1725	850 x 560 x 500	90	500	yes	12000	d
FHA 13/110/1250	1350	110	1250	590 x 1450 x 520	130	1440	1975	850 x 560 x 500	90	610	yes	20000	d

Horizontal and Vertical Split Tube Furnaces (may need further equipment)

FST 13/40/200	1300	40	200	530 x 460 x 560	35	450	985	480 x 560 x 500	50	100	no	1500	a
FST 13/70/500	1300	70	500	530 x 680 x 560	50	670	1205	480 x 560 x 500	50	250	yes	3000	a
FST 13/100/500	1300	100	500	530 x 680 x 560	75	670	1205	850 x 560 x 500	60	250	yes	4000	b

i Please note:
 - Further to the depth of the control module 150 mm for the power plugs and other plugs needs to be added
 - The power supply is based on 200–240 V for 1 phase and 380–415 V for 3 phase power
 - Minimum uniform length in horizontal furnace with insulation plugs fitted at 100°C below max. temperature

Power supply
 a = 1 phase (16A)+N
 b = 3 phase (16A)+N
 c = 3 phase (32A)+N
 d = 3 phase (63A)+N

**AZ – Eight-zone Tube Furnace
up to 1300°C**



**Eight zone tube furnace for
controlled temperature profiles**

The AZ is a tube furnace consisting of eight independent heating zones. These zones can be used to generate temperature profiles along the heated length of the furnace.

The tube furnace is based on an F-type tube furnace. The heating elements consist of a CrFeAl alloy also known as APM. The APM wire has a diameter of 5 mm. The exposed CrFeAl heating coil is mounted on a ceramic fibre module creating a robust design. Low mass ceramic fibre insulation stores a minimum amount of heat that provides a high overall efficiency for heating and cooling the furnace. With eight zones, thick insulation, and highly symmetric winding of the heating elements throughout the entire furnace, a uniformity of better than ± 5 K is achieved. A key advantage of the eight individually controlled zones is the expansion of the uniform length inside the furnace. Additionally, the temperature profile can be precisely controlled for linear increases, peaks, or other user defined profiles. One process well suited for the AZ tube furnace is chemical vapor deposition as a temperature gradient can be established in the furnace for evaporation of precursor material at the high temperature end zone and sublimation of the vapor onto the substrate at the cooler temperature end zone.

All zones are individually controlled and monitored with thermocouples. Thermocouples are extended through the insulation and positioned next to the heating elements with 3 m long cables. For additional protection, an independently dedicated thermocouple is attached to an over-temperature controller.



AZ 13/32/360 : Eight zone tube furnace with a heated length of 360 mm up to 1350°C.

Advantages

- Eight-zone control for variable heating profiles
- Gradients, linear increase/decrease etc. of temperature along the heated length
- Extended uniform temperature distribution
- Short heating and cooling rates
- Automatic operation
- Data recording for quality management

Typical applications

Evaporation and sublimation, crystal growing, sublimation, drying, synthesis, annealing

Application Example

Growth of Silicon-Based nanostructures in a multi-zone tube furnace



Silicon based nano-materials are potential candidates for one dimensional quantum transistors and light emitting diodes. Among other manufacturing techniques, such as lithography and etching, thermal evaporation and sublimation inside a multi-zone tube furnace is a cost effective production method. SiO powder is evaporated at 1350°C and sublimated onto wafers. The precise control of each temperature zone is critical in controlling the morphology, size, and composition of the Si-based nano-structures. For such applications, the AZ is an important tool toward the design of such nano-structures.

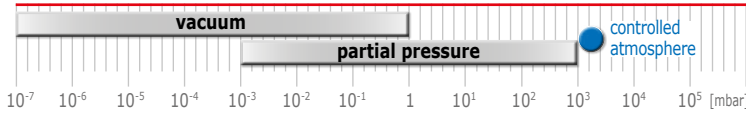

AZ – Eight-zone Tube Furnace up to 1300 °C

Technical details

The ceramic fibre insulation is constructed in multiple layers and assembled with great care to ensure no gaps are present between each of the layers. The insulation layers are arranged with a specific overlap to provide excellent temperature uniformity inside the furnace. The control module is very compact and built into the support frame of the furnace. A touch panel interface provides user-friendly and intuitive control of the furnace operating parameters. No water cooling is necessary as the housing is spaced from the insulation such that it is cooled by convective cooling. The only instances that require water cooling are for use with cooled work tube flanges, i.e. to assemble a vacuum pumping unit.

View inside

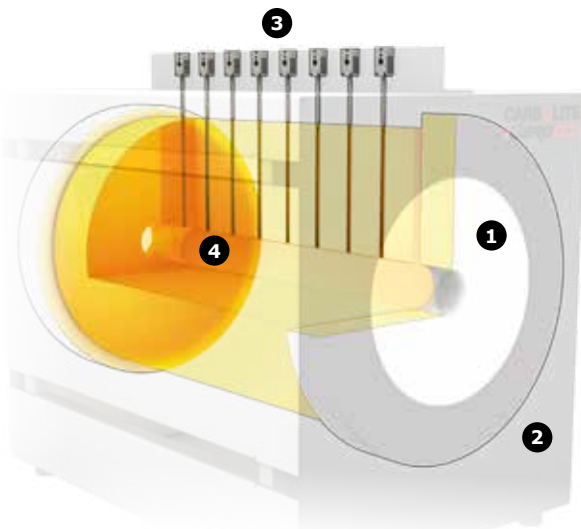

- 1 ceramic fibre insulation
- 2 outer frame
- 3 eight thermocouples for control
- 4 usable volume

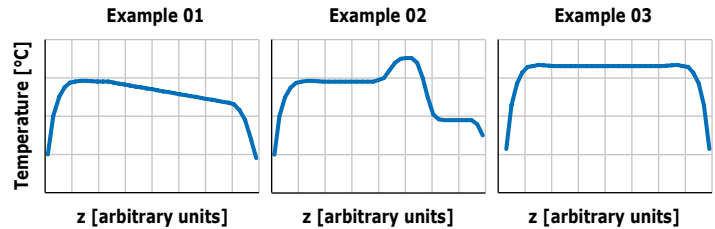

Three typical possible temperature profiles inside the furnace. The eight zones give a maximum of flexibility.

Options

Vacuum System:

- The AZ can be equipped with working tubes made from
- high temperature steel
 - quartz
 - ceramic

When using a work tube, a pumping unit can be configured for the furnace such as the turbomolecular pump or two stage rotary vane pumps. Additionally, other pumps and fast cooling systems can be configured upon request. Information concerning the work tubes are available on page 82.

Software:

The software user interface takes place on a Mini 8 control unit. The system can store 12 programs with 15 segments. All eight heating zones can be controlled by set point value while the actual values are displayed and recorded. The system is also equipped with an over-temperature protection for unattended furnace operation. The system is fully programmable with data storage for further evaluation.



Touch panel interface for furnace control and process visualization.

Technical data

Model	T _{max} [°C]	Dimensions: External H x W x D [mm]	Diameter accessory tube [mm]	Heated length [mm]	Transport weight [kg]	Power [W]	Voltage [V]	Current [A]	Series fuse [A]
AZ 13/32/360	1350	990 x 1800 x 500	32	360	500	1500	400 (3P)	3 x 4	3 x 16
AZ 13/50/430	1350	990 x 1800 x 500	50	430	550	2900	400 (3P)	3 x 9	3 x 16
AZ 13/80/810	1350	990 x 1800 x 500	80	810	600	7300	400 (3P)	3 x 12	3 x 16
AZ 13/110/1000	1350	1200 x 1800 x 520	110	1000	650	11300	400 (3P)	3 x 19	3 x 25

In this temperature range, tube furnaces or hot wall furnaces use MoSi_2 heating elements for a maximum temperature of 1800°C . All other furnaces are referred to as cold wall furnaces as they are equipped with a water cooled vessel. A maximum temperature of 3000°C is possible. For each system, one important and popular application is described briefly.

1300 °C - 3000 °C

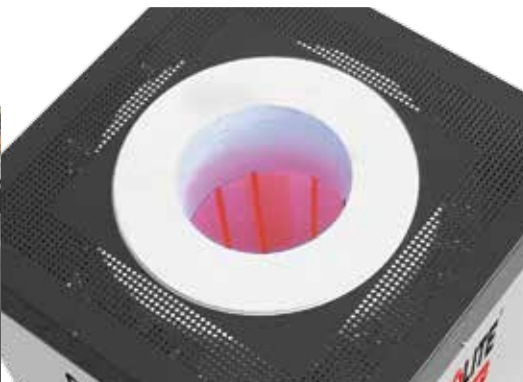

Temperature Range 1300 °C – 3000 °C	Models	Page
Tube Furnaces, Horizontal up to 1800 °C	HTRH	28
Tube Furnaces, Vertical up to 1800 °C	HTRV	30
Split Tube Furnaces, Vertical up to 1700 °C	HTRV-A	31
Hydrogen Tube Furnace up to 1600 °C	HTRH-H₂	32
Chamber Furnaces up to 2200 °C	HTK	34
Chamber Furnaces up to 1800 °C	HTKE	40
Hood Furnaces up to 2200 °C	HBO	42
Hood Furnaces up to 1800 °C	HB	46
Bottom Loading Furnaces up to 2200 °C	HTBL	48
Laboratory Furnaces up to 3000 °C	LHT	52
Bridgman Crystal Growth Furnaces up to 1800 °C	BV-HTRV	56
Partial Pressure Sintering Furnace up to 1450 °C	PDS	58

HTRH – Tube Furnaces, Horizontal up to 1800°C

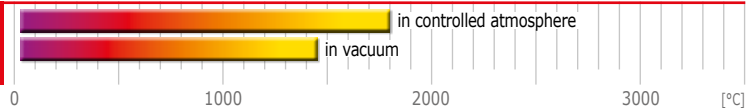

High temperature horizontal tube furnace

Carbolite Gero high temperature tube furnaces, type HTRH, can be operated in a horizontal position up to 1800°C.

The high-grade insulation materials consist of vacuum formed fibre that guarantees low energy consumption and high heating rates due to their low thermal conductivity. The insulation and molybdenum disilicide (MoSi_2) heating elements are installed in the rectangular housing. The heating elements are installed in a vertical, hanging position (see figure) and can be replaced easily. At higher temperatures and in the presence of Oxygen, MoSi_2 develops an oxide (SiO_2) layer, which protects the heating elements against further thermal or chemical corrosion. With its wide range of accessories, the comprehensive HTRH series provides complete system solutions for ambitious thermal treatment in the high temperature range.



HTRH 18/40/100: High temperature horizontal tube furnace (without control module) with a heated length of 100 mm up to 1800°C.

Advantages

- Exceptional long-term stability
- Vacuum equipment available
- Inert and reactive gas equipment available
- High grade thermocouple type B
- Low thermal mass ceramic fibre insulation
- High quality MoSi_2 heating elements in a vertical, hanging position
- Rectangular housing with holes for convection cooling
- Available with 1 – 3 heating zones

Options

(available for all tube furnaces)

- Cascade control available
- Over-temperature protection (recommended to protect valuable contents & for unattended operation)
- A range of sophisticated digital controllers, multi-segment programmers, and data logger are available that can be configured with RS 232, RS 485, or Ethernet communication adapters (see pages 74 and 80)

Application Example

Calibration of temperature sensors (e. g. thermocouples)



Calibration body to insert thermocouples

With a growing number of high temperature applications, the precise determination of the applied temperature is crucial for quality control of known products and for research and development of new production techniques. Additionally, for the calibration of a variety of temperature sensors, a very stable and uniform heat is required. For this purpose, the HTRH horizontal tube furnace provides an exceptionally stable and uniform quality of heat at medium and high temperatures up to 1800°C. Several calibration and gauging institutes all over the world use Carbolite Gero tube furnaces as a reliable and precise heat source for their calibration procedure and quality control.

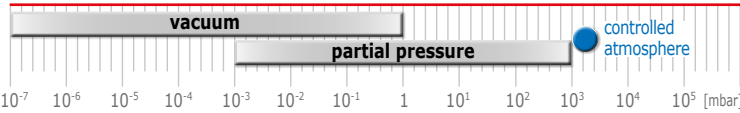

HTRH – Tube Furnaces, Horizontal up to 1800 °C

HTRH furnace with three heating zones

Better temperature uniformity can be achieved by dividing the heated length into 3 zones.

Each zone is equipped with a dedicated thermocouple and controller, which is especially useful to preheat gases required for reactions inside the system. The HTRH tube furnaces do not include an integral work tube. The work tube must be selected as an additional item. The work tube length is dependent on the application and will vary if used with or without modified atmosphere or vacuum.

Typical applications

Hardening, annealing, tempering, soldering, brazing, degassing, calcination, sintering, synthesis, sublimation, drying, MIM, CIM, miniplants, ageing, catalyst research, pyrolysis, thermocouple calibration, test fuel cells, coating, CVD

View inside

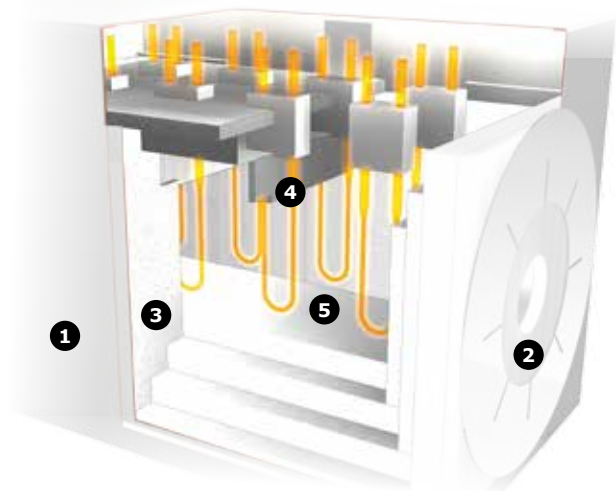

- 1 outer case
- 2 ceramic fibre end insulation
- 3 ceramic fibre case insulation
- 4 heating elements
- 5 ceramic fibre inner insulation

Technical data

Model	T _{max} [°C]	Max. outer diameter accessory tube [mm]	Heated length [mm]	Dimensions: External H x W x D [mm]	Furnace weight [kg]	Recommended tube length		Dimensions: Control module H x W x D* [mm]	Control module weight [kg]	Uniform length ± 5°C [mm]	Power [W]	Power supply
						for use in air [mm]	for use with modified atmosphere [mm]					

Horizontal Single Zone Furnaces

HTRH ___/40/100	1600, 1700, 1800	40	100	510 x 390 x 420	45	380	915	480 x 560 x 500	50	50	2200	a
HTRH ___/40/250	1600, 1700, 1800	40	250	510 x 540 x 420	45	530	1065	480 x 560 x 500	50	125	3600	a
HTRH ___/40/500	1600, 1700, 1800	40	500	510 x 790 x 420	60	780	1275	850 x 560 x 500	90	250	8000	c
HTRH ___/70/150	1600, 1700, 1800	70	150	620 x 450 x 520	90	440	975	480 x 560 x 500	60	75	4500	b
HTRH ___/70/300	1600, 1700, 1800	70	300	620 x 590 x 520	65	580	1115	850 x 560 x 500	60	150	6400	b
HTRH ___/70/600	1600, 1700, 1800	70	600	620 x 890 x 520	90	880	1415	850 x 560 x 500	90	300	8000	c
HTRH ___/100/150	1600, 1700, 1800	100	150	620 x 450 x 520	120	440	975	480 x 560 x 500	60	75	4800	b
HTRH ___/100/300	1600, 1700, 1800	100	300	620 x 590 x 520	65	580	1115	850 x 560 x 500	90	150	7500	c
HTRH ___/100/600	1600, 1700, 1800	100	600	620 x 890 x 520	90	880	1415	850 x 560 x 500	90	300	10900	c
HTRH ___/150/300	1600, 1700, 1800	150	300	670 x 590 x 570	120	580	Not available	850 x 560 x 500	90	150	8000	c
HTRH ___/150/600	1600, 1700, 1800	150	600	670 x 890 x 570	140	880	Not available	850 x 560 x 500	90	300	12000	c
HTRH ___/200/300	1600, 1700, 1800	200	300	720 x 590 x 620	180	580	Not available	850 x 560 x 500	90	150	10000	c
HTRH ___/200/600	1600, 1700, 1800	200	600	720 x 890 x 620	140	880	Not available	850 x 560 x 500	90	300	12000	c

Horizontal Three Zone Furnaces

HTRH-3 ___/70/600	1600, 1700, 1800	70	600	620 x 890 x 520	120	880	1415	850 x 560 x 500	180	350	8000	c
HTRH-3 ___/100/600	1600, 1700, 1800	100	600	620 x 890 x 520	120	880	1415	850 x 560 x 500	180	350	10900	c
HTRH-3 ___/150/600	1600, 1700, 1800	150	600	670 x 890 x 570	180	880	Not available	850 x 560 x 500	180	350	12000	c

i Please note:
 - Further to the depth of the control module 150 mm for the power plugs and other plugs needs to be added
 - The power supply is based on 200–240 V for 1 phase and 380–415 V for 3 phase power
 - Minimum uniform length in horizontal furnace with insulation plugs fitted at 100°C below max. temperature
 - Maximum continuous operating temperature is 100°C below maximum temperature

Power supply
 a = 1 phase (16A)+N
 b = 3 phase (16A)+N
 c = 3 phase (32A)+N
 d = 3 phase (63A)+N

**HTRV – Tube Furnaces,
 Vertical up to 1800°C**

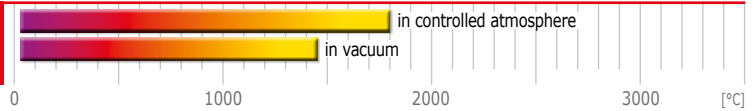

High temperature vertical tube furnace

The HTRV high temperature tube furnace is optimally designed for vertical positioning and operation up to 1800°C.

The high grade insulation material consisting of vacuum formed fibre plates provide low energy consumption and high heating rates due to their low thermal conductivity. The insulation and the molybdenum disilicide (MoSi₂) heating elements are installed in a rectangular housing. The heating elements are installed in a hanging, vertical position in the interior (see figure) and can be easily replaced. At higher temperatures and in the presence of Oxygen, MoSi₂ develops an oxide layer which protects the heating elements against further thermal or chemical corrosion. With its wide range of accessories, the comprehensive HTRV series provides complete system solutions for ambitious thermal treatment at high temperatures.

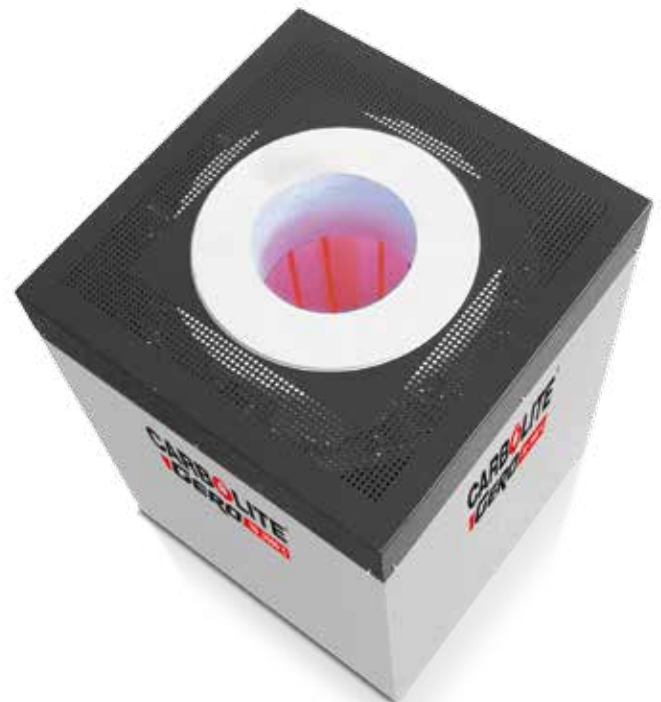

HTRV 18/40/100: High temperature, vertical tube furnace with a heated length of 100 mm up to 1800°C.

Advantages HTRV & HTRV-A

- Optimized for vertical usage
- Vacuum equipment available
- Inert and reactive gas equipment available
- High grade thermocouple type B
- Low thermal mass ceramic fibre insulation
- High quality MoSi₂ heating elements in a vertical, hanging position
- Rectangular housing with holes for convection cooling

For further options see pages 28, 74 and 80

**Typical applications HTRV & HTRV-A
 (may need further equipment)**

Hardening, annealing, tempering, soldering, brazing, degassing, calcination, sintering, synthesis, sublimation, drying, MIM, CIM

View inside the HTRV-A

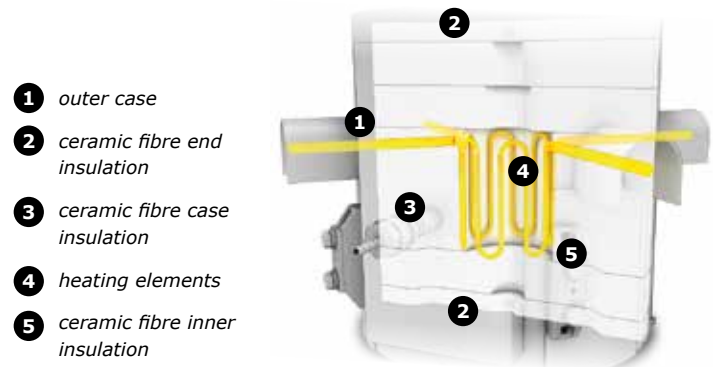

Application Example

Melting different types of rocks for volcano studies



A curious application for the HTRV vertical tube furnace is the determination of the viscosity (a measurement of a fluid's resistance to flow) of molten rock, also known as magma. For this purpose, various rock types are heated to examine their behavior at different temperatures up to 1800°C. This basic research provides a better understanding of the behavior and properties of molten and half molten layers of rock during volcanic eruptions and earthquakes. Determining the viscosity of the layers is important data for computer simulations and are used to conduct adequate risk assessment for a single volcano or in high risk earthquake areas, such as California or Japan, this fundamental research assists in the prediction of dangerous situations, and therefore, helps to save lives.

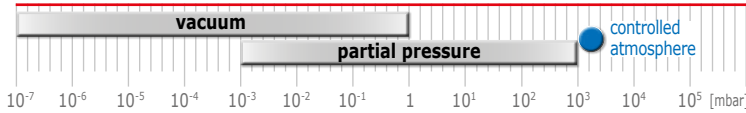

HTRV-A – Split Tube Furnaces, Vertical up to 1700°C

High temperature vertical split tube furnace

The HTRV-A split tube furnace is a vertical tube furnace that operates to a maximum of 1700°C.

The split tube arrangement of the heating module allows for an easy positioning of the work tube or even whole reactors with multiple adapters. The opening capability of the furnace can allow for faster cooling of samples as well. The insulation consists of light, multi-layer fibre material. The furnace is also equipped with a control thermocouple installed in the center of the heating zone. Carbolite Gero offers a wide assortment of options, modifications, and the expertise to create a custom solution for your heat treatment needs.

The split rectangular housing is engineered with cooling channels to aid in convection cooling of the outer case similar to the HTRV-Series furnaces. The two chamber halves of the furnace consist of high grade insulation plates with MoSi₂ heating elements hanging vertically from the chamber ceiling. A safety door switch protects the user by switching off the heating elements once the door is opened.



HTRV-A 17/70/250: High temperature vertical split tube furnace with a heated length of 250 mm up to 1700°C.

Additional advantages for HTRV-A

- Large flanges can stay attached to the tube
- Intricately shaped tubes and tube accessory configurations (e.g. reactors with many inlets and outlets) can be placed in the heating zone without disassembly

Technical data

Model	T _{max} [°C]	Max outer diameter accessory tube [mm]	Heated length [mm]	Dimensions: External H x W x D [mm]	Furnace weight [kg]	Recommended tube length		Dimensions: Control module H x W x D* [mm]	Control module weight [kg]	Uniform length ± 5°C [mm]	Power [W]	Power supply
						for use in air [mm]	for use with modified atmosphere [mm]					

Vertical Tube Furnaces

HTRV ___/40/100	1600, 1700	40	100	365 x 455 x 455	30	355	890	480 x 560 x 500	50	50	2000	a
HTRV ___/40/250	1600, 1700, 1800	40	250	515 x 455 x 455	40	505	1040	480 x 560 x 500	50	125	3000	a
HTRV ___/40/500	1600, 1700	40	500	765 x 455 x 455	65	755	1290	850 x 560 x 500	60	250	6000	b
HTRV ___/70/100	1600, 1700	70	100	365 x 455 x 455	30	355	890	480 x 560 x 500	50	50	3000	a
HTRV ___/70/250	1600, 1700, 1800	70	250	515 x 455 x 455	40	505	1040	850 x 560 x 500	60	125	4800	b
HTRV ___/70/500	1600, 1700, 1800	70	500	765 x 455 x 455	65	755	1290	850 x 560 x 500	90	250	8000	c
HTRV ___/100/250	1600, 1700, 1800	100	250	515 x 455 x 455	45	505	1040	850 x 560 x 500	60	125	6400	b
HTRV ___/100/500	1600, 1700, 1800	100	500	765 x 455 x 455	70	755	1290	850 x 560 x 500	90	250	10400	c
HTRV ___/150/250	1600, 1700, 1800	150	250	515 x 580 x 580	55	505	Not available	850 x 560 x 500	90	125	8000	c
HTRV ___/150/500	1600, 1700, 1800	150	500	765 x 580 x 580	80	755	Not available	850 x 560 x 500	90	250	12000	d
HTRV ___/200/250	1600, 1700, 1800	200	250	515 x 580 x 580	70	505	Not available	850 x 560 x 500	90	125	10000	c
HTRV ___/200/500	1600, 1700, 1800	200	500	365 x 580 x 580	95	755	Not available	850 x 560 x 500	90	250	18500	d

Vertical Split Tube Furnace

HTRV-A ___/70/250	1600, 1700	70	250	800 x 600 x 890 (closed with stand)	75	600	1040	850 x 560 x 500	90	125	6000	c
-------------------	------------	----	-----	-------------------------------------	----	-----	------	-----------------	----	-----	------	---

- i Please note:**
- Further to the depth of the control module 150 mm for the power plugs and other plugs needs to be added
 - The power supply is based on 200–240 V for 1 phase and 380–415 V for 3 phase power
 - Minimum uniform length in horizontal furnace with insulation plugs fitted at 100°C below max. temperature
 - Maximum continuous operating temperature is 100°C below maximum temperature

- Power supply
- a = 1 phase (16A)+N
 - b = 3 phase (16A)+N
 - c = 3 phase (32A)+N
 - d = 3 phase (63A)+N

HTRH-H₂ – Hydrogen Tube Furnace up to 1600°C

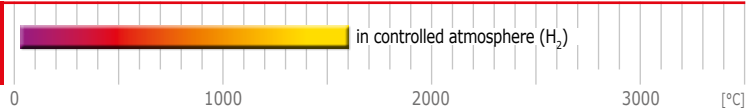

Tube furnace with Hydrogen atmosphere

The Hydrogen tube furnace system is based on the popular HTRH 16/100/600 system. The furnace is designed to meet all required regulations for the safe handling of Hydrogen gas.

In principle, every tube furnace can be modified to safely work with Hydrogen. This system is based on the long established HTRH 16/100/600 tube furnace. The system utilizes a ceramic tube with water-cooled, leak tight flanges at both ends. The tube furnace is able to provide heat treatment up to 1600°C even in a pure Hydrogen atmosphere. The ceramic tube is automatically flooded with inert gas prior to the introduction of Hydrogen gas for safety. Inert gas is provided by a flooding tank system that is filled with inert gas at high pressure. To purge remaining Oxygen out of the tube prior to heat treatment, the flooding tank is discharged and is then refilled. The gas outlet system is connected to an afterburner for outgoing Hydrogen combustion.

The gas inlet to the afterburner is heated to prevent any condensate formation in the system. The afterburner is driven by compressed air and propane gas. The afterburner will combust Hydrogen and all other gaseous by-products generated during the process.

All gases are controlled by means of a fully automated flow controller. In the event a malfunction is detected, the system is immediately brought to a secure state. All devices are manufactured to adhere to SIL2 standards. A Hydrogen sensor is installed at the top of the furnace, and in the event that a Hydrogen leak is detected, the sensor immediately responds. If a Hydrogen leak is detected, the furnace is flooded with inert gas, and the system is brought to a safe status. Furnace controls are programmed with an intuitive and user-friendly touch panel interface.

All tube furnaces can serve as a base system to be used with Hydrogen; hence, different usable spaces and temperatures are possible. If Hydrogen at more than 1800°C is required, a cold wall furnace must be selected.

Typical applications

Annealing, tempering, quenching, soldering, brazing, degassing, pyrolysis, rapid prototyping, sintering, debinding, synthesis, sublimation, drying, MIM, CIM



HTRH 16/100/600: Hydrogen tube furnace with a heated length of 600 mm up to 1600°C. Operation under pure Hydrogen is possible. All safety provisions are implemented.

Advantages

- Hydrogen use up to 100% purity
- Afterburner and flooding tank safety systems
- All safety provisions for Hydrogen operation
- Reduction of Oxygen by inert gas purging
- Automatic operation
- Data recording for quality management

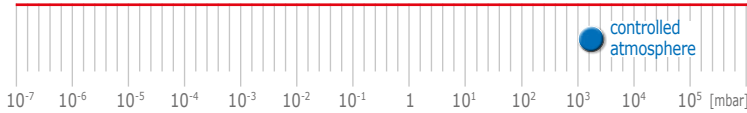

HTRH-H₂ – Hydrogen Tube Furnace up to 1600 °C



The flooding tank is filled with Nitrogen at a pressure of 8 bar. The flooding tank is a required safety option when working with pure Hydrogen.

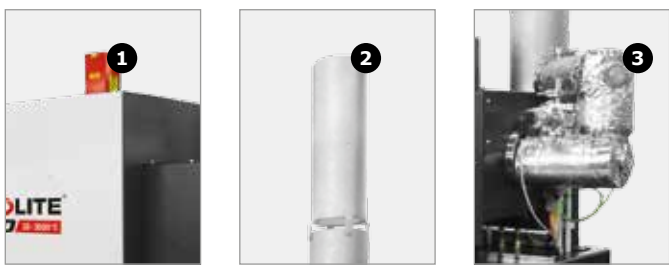
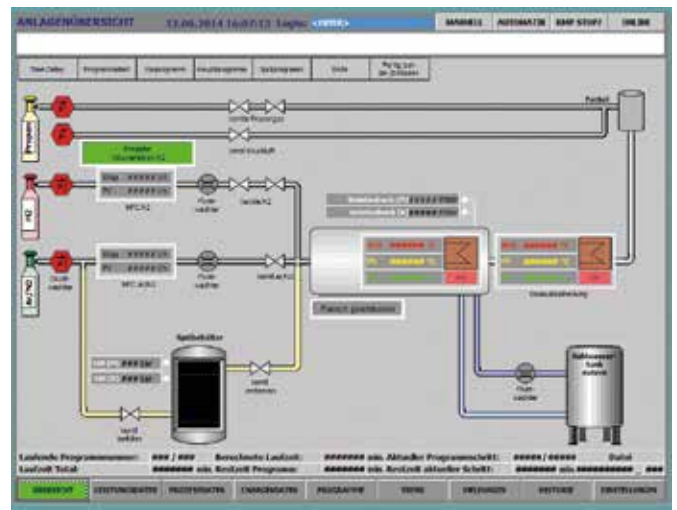

- 1** Hydrogen sensor
- 2** afterburner
- 3** heated gas outlet system
- 4** touchpanel for automatic operation

A touch panel interface is used for automated operation. All valves, temperatures, gas flows, etc. can be switched on and off manually or automatically by a predetermined program.

Options

Vacuum System:

Different tube furnaces can be equipped with working tubes made from

- high temperature steel
- quartz
- ceramic

With a work tube, a pumping unit can be attached such as the turbomolecular pump or two stage rotary vane pumps. Other pumps can be configured upon request as well as fast cooling options. The information concerning work tubes are available on page 82.

Tube furnace:

The tube furnaces from the F, HTRH, HTRV series can all be equipped with the Hydrogen option like described above.

Application Example

Heat treatment of soft magnetic material



For many sensitive applications or measurements, it is important to shield the environment completely against electromagnetic fields. Generally, shielding is performed with magnetic material with high permeability. The shielding material is known as Mu-Metal® and is processed under Hydrogen at a temperature of 1200 °C for several hours. After the heat treatment process, the material must be treated with great care in order to not degrade the achieved magnetic properties.

Foil from Mu-Metal® to shield magnetic fields. With friendly permission of Vacuumschmelze.

**HTK – Chamber Furnaces
up to 2200°C**

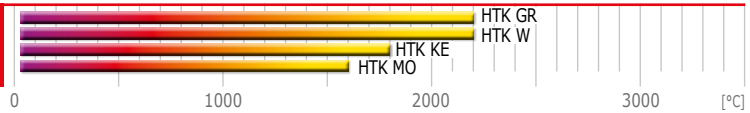

High temperature chamber furnaces

The HTK range is available in three different versions: graphite, metallic material (tungsten or molybdenum) or ceramic fibre. These different base materials enable a broad application range.

The rectangular design with a front door allows for easy loading and unloading. The HTK range is available in up to six different sizes. The smallest designs with a capacity of 8 litres and 25 litres are typically employed by laboratories for research and development. The 80 litre, 220 litre, 400 litre or 600 litre furnaces are predominantly used as pilot manufacturing systems or large scale production. The HTK GR is based on Graphite insulation material, as well as graphite heating elements. With maximum temperatures up to 2200°C, the HTK GR is suited for extreme heat treatment needs. Upon request, the system can be equipped with a Graphite retort that is capable of a defined gas guiding flow within the unit and improves temperature uniformity to $< \pm 10^\circ\text{C}$. For processes with strong outgassing, the retort protects the heating elements and increases the lifetime of the furnace. The HTK furnaces can operate with rough/fine vacuum, protective gases such as Nitrogen/Argon, and reactive gases like Hydrogen and Carbon Monoxide. The HTK GR cannot operate in an Oxygen atmosphere.

The metallic furnaces constructed of tungsten (HTK W) or molybdenum (HTK MO) permit the greatest possible purity of inert atmosphere and final vacuum level in the high vacuum region (5×10^{-6} mbar). Upon request, an ultra-high vacuum can be configured. Common gases that are typically used include: Nitrogen, Argon, Hydrogen or mixtures. The heating elements are made from the same metallic material as the insulation. The heating insulation is constructed of several radiation shields constructed from tungsten or molybdenum with respect to the furnace type selected. A retort can be utilized for gas flow guidance or to improve the temperature uniformity. The maximum temperature for the HTK W is 2200°C and 1600°C in the HTK MO.

The ceramic fibre insulated furnaces (HTK KE) can be used under a defined Oxygen mixture or 100% pure Oxygen. The heating elements are CrFeAl, allowing temperatures of up to 1350°C, or MoSi₂ that allow temperatures up to 1800°C. Inert gas atmospheres are possible; however, poor atmospheric quality must be accepted. Due to the porous nature of the insulation, vacuum operation is limited to a rough vacuum range for short durations.



HTK 400 GR/22: High temperature chamber furnace with a usable volume of 400 l up to 2200°C with automated operation via a touch panel interface.

Advantages

- Metallic furnaces provide a precisely defined atmosphere with the highest possible purity (6 N or better)
- Metallic furnaces offer the best possible vacuum
- Graphite furnaces offer the highest possible temperatures
- Hydrogen partial pressure operation if requested
- Operation under air or with 100% Oxygen in the HTK KE
- Precisely controlled vacuum pumping speeds appropriate for powders
- Data recording for quality management

Typical applications

HTK Graphite insulation:

Pyrolysis, sintering, siliconization, graphiting and technical ceramics such as SiC, SiN, BC, AlN and combinations

HTK metallic insulation:

Metal powder injection molding (MIM), carbon free atmosphere, sintering, metallization, etc.

HTK ceramic fibre insulation:

Ceramic injection molding (CIM), debinding and sintering in air

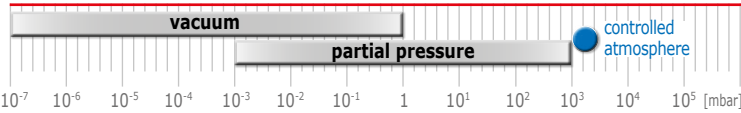

HTK – Chamber Furnaces up to 2200°C

Technical details

Inside the chamber, heating elements are positioned at the bottom, left, right, and top sides of the furnace chamber allowing for improved temperature uniformity. For larger volumes, the back wall and front are equipped with heating elements to maintain excellent temperature uniformity. The HTK W, HTK MO, HTK GR and HTK KE furnaces are surrounded by a water cooled vessel; thus classifying, the HTK systems as a cold wall furnace. The cooling water is guided through the double walled vessel.

Upon request, the HTK GR can be operated up to 3000°C. For operation at 3000°C, the furnace is specially designed with a specific isolation thickness, optimal positioning of the heating elements, and a pyrometer for temperature measurement and control. The pyrometer directly measures

the heat radiation by optical methods via a window inside the furnace and is not directly inserted into the furnace. This measurement principle only works if a sufficient amount of radiation is emitted. The needed radiation is only generated at temperatures exceeding 400°C. For lower temperatures, a sliding thermocouple is used to control the lower temperatures. Because of the increasing vapor pressure of graphite, 3000°C operation is only possible under inert gas atmosphere. Additionally, the high vapor pressure also results in carbon being released to the atmosphere. For carbon sensitive samples, a metallic furnace must be used. More details for 3000°C furnaces are provided in the chapter *SERIE 3000*.



Screenshot of the visualization of an automatic operating furnace.



HTK 8 GR/22: Chamber furnace with a usable volume of 8 l up to 2200°C. The graphite insulation is built up by the layering of several insulation partitions. Inside the heating cassette is a centered retort.

Application Example

Sintering of magnetic materials in the metallic HTK

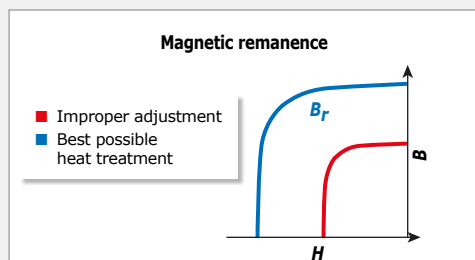

The right heat treatment leads to high magnetic remanence B_r (blue curve). With the improper adjustments (red curve) the magnetic properties are degraded. The heat treatment must be chosen carefully.

Magnetic materials have a very wide range of applications and are often used in power generators, transformers, electric motors, and cores for magnetic flux. To increase the efficiency and improve the quality of those devices, it is paramount to have good magnetic properties of the materials, such as high remanence (B_r) of hard magnetic material (permanent magnets) or high initial permeability for soft magnetic materials. Soft magnetic materials cover a huge market of various products – about 7×10^6 tons annually. The magnetic properties can be improved and controlled by proper heat treatment. To avoid any oxidation, the highest atmospheric purity must be ensured during heat treatment and carried out under vacuum or Hydrogen gas environment. For such a demanding process, the HTK, with metallic insulation, is ideal. The heat treatment is reproducible and reliable due to the programmable software. For loading and unloading samples, the HTK can be attached to a glove box as required.

HTK – Chamber Furnaces up to 2200 °C

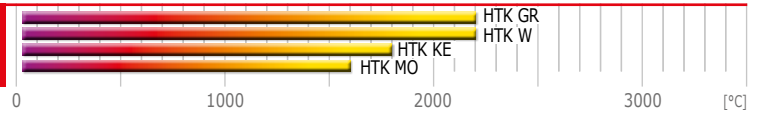

The HTK series are used in a broad range of applications as three different insulation and heating principles are available.

Graphite furnace



These furnaces are employed under vacuum/high vacuum, protective gases such as Nitrogen/Argon, but also with reaction gases like Hydrogen and Carbon Monoxide. Operation with air is not permitted.

Applications include technical ceramics such as SIC, SIN, BC, ALN and combinations. In the field of composite materials, the HTK systems are used for pyrolysis, sintering, siliconizing, and carbonizing.

Metallic furnace made of Molybdenum and Tungsten

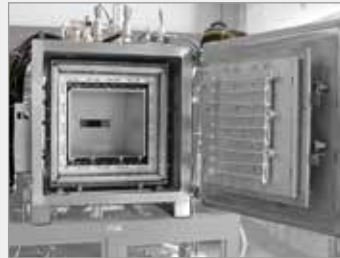

The highest possible purity of atmosphere and vacuum level can be achieved in the metallic furnaces as porous fibre insulation is not used in its construction.

The sophisticated designs are employed for specimens requiring treatment in carbon-free atmospheres. Applications can be found in the lighting industry, metal powder injection molding, tempering of sapphires, heat treatment of metals, sintering of pellets in nuclear industries, manufacturing of radar tubes, metallization of ceramic components, high vacuum brazing, etc.

Ceramic fibre insulated furnace



Chamber furnaces with ceramic fibre lining are employed for processes with defined Oxygen percentages or 100% Oxygen atmosphere. Processes involving Nitrogen and Argon are also possible, but the atmosphere will not be as pure.

Processes for piezoceramic materials are possible, and all oxide materials can be sintered. Other possibilities include the heat treatment of metals, crystal growth, and ceramic powder manufacturing.

View inside

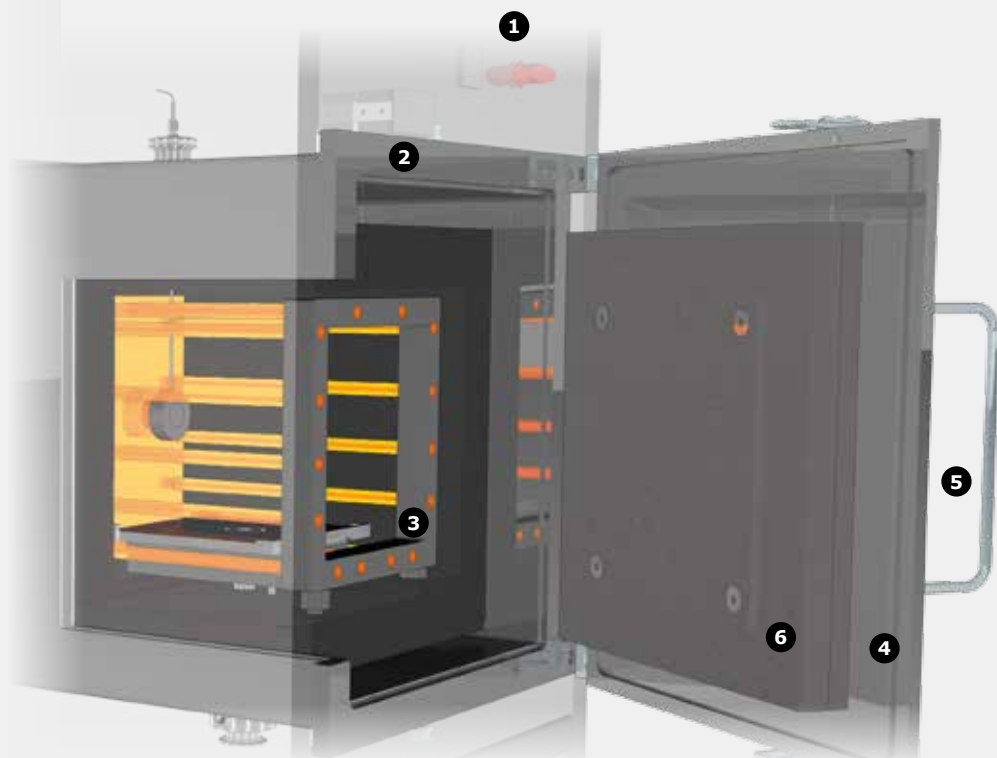

- 1 frame
- 2 water cooled vessel
- 3 heating cassette
- 4 groove for the sealing
- 5 front door
- 6 graphite insulation

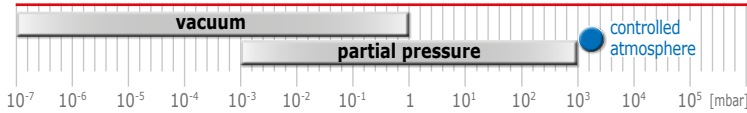

Options

All HTK models are available with manual or automated controls. The manual version can be purchased only for processes that do not require reactive gases. If reactive gases are used, such as Hydrogen, the automated control version is supplied with all safety relevant provisions (SIL2).

Vacuum System:

All HTK models can be equipped with a pre-pump for pre-vacuum operation. For fine vacuum operation, a pre-pump is combined with a roots pump. For high vacuum operation, the pre-pump is combined with a turbomolecular pump. The pumping speeds vary depending on the size of the furnace.

- Single or double stage rotary vane pump: Primarily used for reducing the Oxygen level prior to heat treatment by several cycles of evacuation and inert gas flooding. Pump may also be used as a pre-pump. The pumping speed is up to 300 m³/h for the HTK 600 GR.
- Roots pump: For applications requiring the fine vacuum range, the roots pump is a reliable option. The required pre-pump is specifically selected for the desired vacuum range of the furnace and must be used in tandem with the roots pump.
- Turbomolecular pumps: Applications demanding high vacuum ranges or very pure atmospheres will require the use of a turbomolecular pump. Unit can be used for both graphite and metallic based HTKs.
- Oil diffusion pumps: Pumping speeds up to 20000 m³/h are recommended for fast evacuation of the large volume HTK models.

Software:

Manual furnaces are operated by Eurotherm controllers in combination with the KP 300 panel. Valves and pumps are operated by simple push buttons on the panel. For data logging purposes, iTools software and PC connectivity are available.

- Eurotherm 3508: 10 different storable programs with 500 different segments.
- Eurotherm 3508: 50 different storable programs with 500 different segments
- RS 232/485
- iTools OPTION
- Over-temperature protection option (recommended for continuous and unattended use)
- Remote control

TP 1900 software or WinCC are available for automated programming of the furnace. The furnace operation is visual and intuitive. WinCC operation features more options that are visually represented on the touch screen interface. With both software systems, a csv file can be generated for later evaluations.

- TP 1900: 20 different heat programs can be stored. Each consisting of up to 25 different segments.
- WinCC: 50 different heat programs can be stored. Each consisting of up to 30 different segments.

Reaction gas equipment:

If Hydrogen is used in a mixture of more than 4%, the furnace will be equipped with an afterburner. The gas outlet can also be heated to prevent possible condensation. Upon request, more than one inert gas can be attached to the furnace. A retort may be also be installed to protect the heating elements or to ensure a defined gas guiding pathway through the furnace.

- Reaction gas equipment
- Safety package for combustible gases
- Debinding unit with active flame for combustion
- More than one inert gas
- Retort

Water cooling:

If on-site water cooling is unavailable, a cooling system may be ordered. The cooling power will be designed to meet the requirements of the furnace and on-site power availability.

- Water cooling system: Chiller



Depending on the maximum power of the furnace, a suitable water cooling system can be supplied from Cabolite Gero.

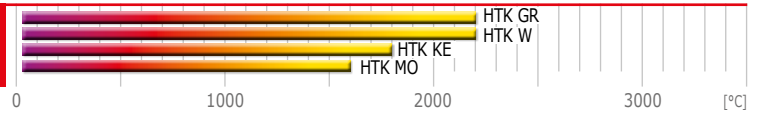

Technical data



Model

Graphite

HTK 8 GR/22-1G	HTK 25 GR/22-1G	HTK 80 GR/22-1G	HTK 220 GR/22-1G	HTK 400 GR/22-1G	HTK 600 GR/22-1G

External dimensions

H x W x D [mm]	2100 x 1300 x 1100	2200 x 1900 x 1800	2300 x 2100 x 2200	2500 x 2300 x 2600	2500 x 2300 x 2600	2500 x 2500 x 2900
-----------------------	--------------------	--------------------	--------------------	--------------------	--------------------	--------------------

Transport weight

Complete system [kg]	1200	1700	2000	3000	3800	4500
-----------------------------	------	------	------	------	------	------

Usable space

Volume [l]	8	25	80	220	400	600
H x W x D, usable space without retort [mm]	200 x 200 x 200	250 x 250 x 400	400 x 400 x 500	600 x 600 x 600	650 x 700 x 900	650 x 750 x 1200
H x W x D, usable space with retort [mm]	180 x 180 x 200	230 x 230 x 400	380 x 380 x 500	560 x 560 x 600	630 x 680 x 900	630 x 730 x 1200

Thermal values

T_{max} vacuum [°C]	2200	2200	2200	2200	2200	2200
T_{max} atmospheric pressure [°C]	2200	2200	2200	2200	2200	2200
ΔT, between 500 °C and 1500 °C, [K] (according to DIN 17052)	± 10	± 10	± 10	± 10	± 10	± 10
Max. heat-up rate [K/min]	10	10	10	10	10	10
Cooling time [h]	6	6	8	8	12	12-16

Connecting values

Power [kW]	26.5	60	100	160	250	300
Voltage [V]	400 (3P)	400 (3P)	400 (3P)	400 (3P)	400 (3P)	400 (3P)
Current [A]	3 x 66	3 x 90	3 x 150	3 x 240	3 x 370	3 x 450
Series fuse [A]	3 x 80	3 x 125	3 x 200	3 x 315	3 x 500	3 x 500

Vacuum (option)

Leakage rate (clean, cold and empty) [mbar l/s]	< 5 x 10 ⁻³
Vacuum range depending on the pumping unit	rough or fine vacuum

Cooling water required

Flow [l/min]	40	70	100	150	200	220
Max. inlet temperature [°C]	23	23	23	23	23	23

Gas supply

Nitrogen or Argon flow, others on request [l/h]	200-2000	200-2000	200-2000	1000-10000	1000-10000	1000-10000
--	----------	----------	----------	------------	------------	------------

Controller

Controller	on request
-------------------	------------

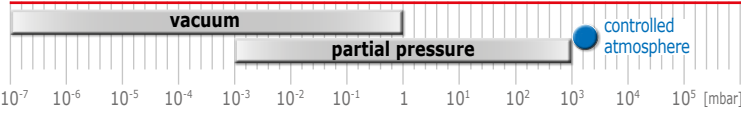

HTK – Chamber Furnaces up to 2200 °C

Molybdenum			Tungsten		Ceramic fibre					
HTK 8 MO/16-1G	HTK 25 MO/16-1G	HTK 80 MO/16-1G	HTK 8 W/22-1G	HTK 25 W/22-1G	HTK 8 KE/13-1G	HTK 25 KE/13-1G	HTK 80 KE/13-1G	HTK 220 KE/13-1G	HTK 400 KE/13-1G	HTK 600 KE/13-1G

2100 x 1300 x 1100	2200 x 1900 x 1800	2300 x 2100 x 2200	2100 x 1300 x 1100	2200 x 1900 x 1800	2100 x 1300 x 1100	2200 x 1900 x 1800	2300 x 2100 x 2200	2500 x 2300 x 2600	2500 x 2300 x 2600	2500 x 2500 x 2900
--------------------	--------------------	--------------------	--------------------	--------------------	--------------------	--------------------	--------------------	--------------------	--------------------	--------------------

1200	1700	2000	1300	1900	1200	1700	2000	3000	3800	4500
------	------	------	------	------	------	------	------	------	------	------

8	25	80	8	25	8	25	80	220	400	600
200 x 200 x 200	250 x 250 x 400	400 x 400 x 500	200 x 200 x 200	250 x 250 x 400	200 x 200 x 200	250 x 250 x 400	400 x 400 x 500	600 x 600 x 600	650 x 700 x 900	650 x 750 x 1200
180 x 180 x 200	230 x 230 x 400	380 x 380 x 500	180 x 180 x 200	230 x 230 x 400	180 x 180 x 200	230 x 230 x 400	380 x 380 x 400	560 x 560 x 600	630 x 680 x 900	630 x 730 x 1200

1600	1600	1600	2200	2200	1100	1100	1100	1100	1100	1100
1600	1600	1600	2200	2200	1350	1350	1350	1350	1350	1350
±5	±5	±5	±5	±5	±10	±10	±10	±10	±10	±10
10	10	10	10	10	10	10	10	10	10	10
6	6	8	6	6	6	6	8	10	12	12-16

30	80	100	45	100	8	16	45	80	120	200
400 (3P)	400 (3P)	400 (3P)	400	400 (3P)	400	400	400	400	400	400
3 x 75	3 x 120	3 x 150	112	3 x 150	20	40	3 x 65	3 x 120	3 x 180	3 x 290
3 x 100	3 x 160	3 x 200	3 x 160	3 x 200	3 x 63	3 x 63	3 x 80	3 x 160	3 x 250	3 x 315

< 5 x 10 ⁻³ rough, fine or high vacuum			< 5 x 10 ⁻³ rough, fine or high vacuum		< 5 x 10 ⁻³ rough or fine vacuum					
--	--	--	--	--	--	--	--	--	--	--

40	70	100	40	100	15	20	40	60	100	175
23	23	23	23	23	23	23	23	23	23	23

200-2000	200-2000	200-2000	200-2000	200-2000	200-2000	200-2000	200-2000	1000-10000	1000-10000	1000-10000
----------	----------	----------	----------	----------	----------	----------	----------	------------	------------	------------

on request			on request		on request					
------------	--	--	------------	--	------------	--	--	--	--	--

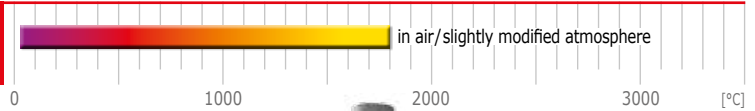
**HTKE – Chamber Furnaces
up to 1800°C**

High temperature chamber furnaces for heat treatment in air

The HTKE is a compact chamber furnace with MoSi₂ heating elements and low-mass, ceramic fibre insulation. Careful design of the insulation ensures optimal temperature uniformity.

The HTKE chamber furnace is available in usable volumes of 32, 64, and 128 litres. Upon request, a maximum volume of 250 litres can be supplied. The chamber is heated by MoSi₂ heating elements that are mounted in a vertical, hanging orientation from the top of the furnace on both the right and left sides of the furnace chamber. The installed power, insulation material and insulation thickness define the maximum temperatures achievable. The HTKE is designed for a maximum temperature of 1600°C, 1700°C, or 1800°C. Heat treatment is only possible in air. An additional gas supply, with hand valve and rotameter, can be supplied, which results in a slight modification of the atmosphere that will only suppress the Oxygen level as the system is not sealed. As a result, the HTKE is ideal for sintering ceramics and oxide ceramics. A temperature uniformity of better than ±5 K is achievable.

The temperature is controlled by a type B thermocouple, which is inserted into a ceramic protection sheath. For unattended operation, an over-temperature thermocouple with controller is recommended.

If debinding is required before sintering, Carbolite Gero offers a debinding package for the HTKE. The debinding package consists of an inlet for preheated air, several gas inlets, and an afterburner. The preheated air is symmetrically purged at several gas inlets into the furnace, which improves temperature uniformity at low temperatures and sample envelopment by the incoming air. All gaseous by-products generated during the debinding process are combusted in an afterburner that is driven by propane gas and compressed air. At the completion of the debinding step, the furnace temperature will increase to begin the sintering process.



HTKE 16/64: High temperature chamber furnace with a usable volume of 64 l up to 1600°C. This model is equipped with an afterburner for debinding processes.

Advantages

- Sintering up to 1800°C in air
- Debinding in air with the debinding package
- High performance ceramic fibre insulation
- Uniform temperature distribution
- Short heating and cooling rates
- Manual operation
- Data recording option

Typical applications

Debinding and sintering in air, drying, annealing, tempering, degassing, sintering, debinding, synthesis, sublimation, drying, CIM

Application Example

Tempering of piezoelectric materials



Piezoelectric materials are of high interest for many applications in the automotive environment. Piezoelectric fuel injection enables the fuel to be injected with a very high pressure in a controlled way. Many modern piezoelectric materials can be manufactured by pressureless sintering in air. This method is easier and more cost effective compared to difficult methods such as cold isostatic processing. The HTKE is the perfect furnace choice. An example of such a material is potassium sodium niobate family (KNN).

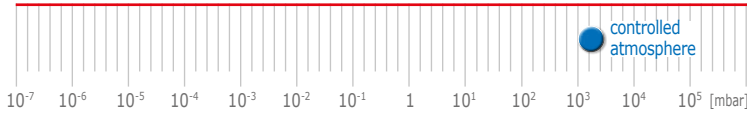

HTKE – Chamber Furnaces up to 1800 °C

Technical details

MoSi₂ U-shaped heating elements are mounted in a vertical, hanging position in the HTKE. Heat is insulated with ceramic fibre plates which are constructed in layers with a suited thickness for improved temperature uniformity. The maximum temperature of the plates is selected depending on the maximum temperature of the furnace. Water cooling is not required as the insulation material has low heat conductance. The system is externally cooled by convection of ambient air and encased by the metallic plates. The MoSi₂ heating elements are especially suited for high temperature processes. At high temperatures, the MoSi₂ naturally creates a protective oxide layer. Outstanding temperature uniformity and compact chamber design are unique features of the HTKE.

View inside

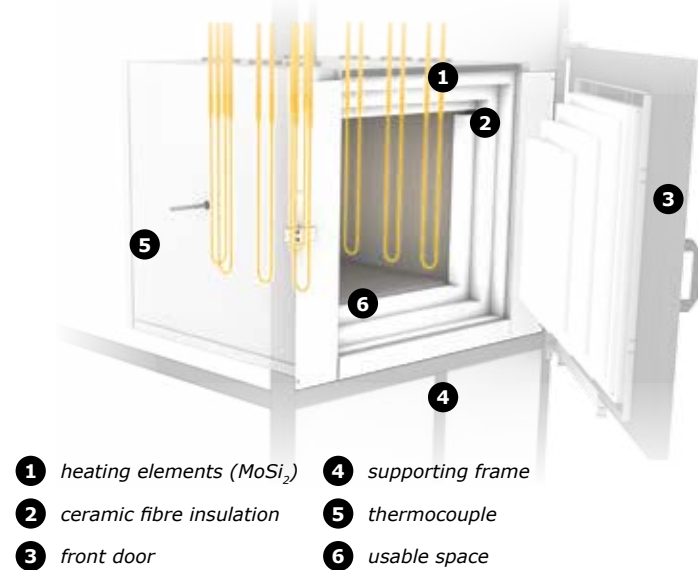

Options

- The HTKE can be equipped with a debinding unit or with an additional gas supply
- Hot air gas blower with controller and exhaust flaps
- Afterburner
- Additional gas inlet with valve and rotameter

Software:

Manual furnaces are operated by Eurotherm controllers in combination with a KP 300 panel. Valves and pumps are operated by simple push buttons on the panel. For data logging purposes, iTools software and PC connectivity are available.

Technical data

Ceramic fibre, non-vacuum tight			
Model	HTKE 32	HTKE 64	HTKE 128
External dimensions			
H x W x D [mm]	1800 x 1000 x 1200	2000 x 1000 x 1200	2000 x 1000 x 1500
Usable space			
Volume [l]	32	64	128
H x W x D [mm]	300 x 300 x 300	400 x 400 x 400	400 x 400 x 800
Thermal values			
T_{max} atmospheric pressure [°C]	1600, 1700, 1800	1600, 1700, 1800	1600, 1700, 1800
Max. dwell time at T_{max} [h]	2	2	2
Max. heat-up rate [K/min]	10	10	10
Cooling time [h]	12	12	12
Connecting values			
Power [kW]	14	16	40
Voltage [V]	400 (3P)	400 (3P)	400 (3P)
Current [A]	3 x 35	3 x 40	3 x 100
Series fuse [A]	3 x 50	3 x 50	3 x 125
Controller			
Controller	on request		
Cooling water required			
Flow [l/min]	no cooling water required		

- Eurotherm 3508: 10 different storable programs with 500 different segments.
- Eurotherm 3508: 50 different storable programs with 500 different segments
- RS 232/485
- iTools OPTION
- Over-temperature protection option (recommended for continuous and unattended use)
- Remote control

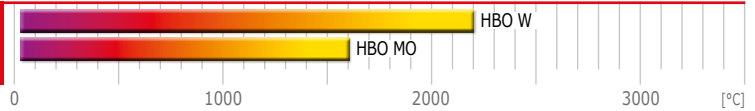

Metallic hood furnaces for applications in atmospheres with highest possible purity

The metallic hood furnaces (HBO) generate the lowest achievable operation pressures. The highest purity gas atmosphere is attained due to the vacuum capability.

The materials used in the construction are selected for the lowest vapour pressures at the highest temperatures. Heat treatment up to the highest temperatures can be achieved without harming the heating elements or insulation material. Radiation shields are used to provide thermal insulation, which are made from the same material as the heating elements, and no fibrous thermal insulation is used. Two varieties of HBO furnaces are produced: those made using molybdenum heating elements and radiation shields are suitable for use up to 1600°C; those made using tungsten heating elements and radiation shields are suitable for use up to 2200°C.

Nitrogen, Argon, and Hydrogen gases are available for use in mixed or pure forms. Additional gases can be installed upon request. A slight overpressure or controlled partial pressure between 10 and 1000 mbar can be achieved. Partial pressure provides a defined gas flow through the furnace.

Due to the complete metallic design, the final vacuum level in the HBO can reach the high vacuum range and better than 5×10^{-6} mbar. Depending on the vacuum requirements, the vacuum is provided by different pumping stations. Ultra-high vacuum options are available upon request. Gases are controlled by various dosing and controlling devices. The temperature in each of the three heating zones is individually controlled to maintain the best uniformity.

Typical applications

Hardening, annealing, tempering, quenching, soldering, brazing, degassing, pyrolysis, siliconization, carbonization, rapid prototyping, sintering, debinding, synthesis, sublimation, drying, MIM, CIM



HBO 60 MO/16: Hood furnace with a usable volume of 60 l up to 1600°C and automated operation via a touch panel interface. A high vacuum pumping unit is attached to the furnace.

Advantages

- Precisely defined atmosphere with highest possible purity (6 N or better)
- Best possible vacuum
- Fast heat up and cool down upon request
- Hydrogen partial pressure operation upon request
- Precisely controlled vacuum pumping speeds appropriate for powders
- Certified safety management for flammable and toxic gases
- Fully automatic operation
- Data recording for quality management

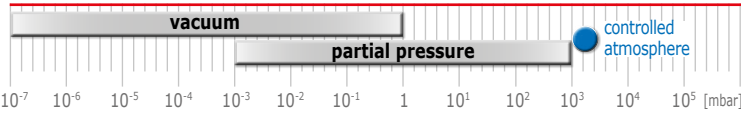

HBO – Hood Furnaces up to 2200 °C

Technical details

The HBO is constructed of metallic materials only with a total of 9 radiation shields. It has three heating zones to improve the temperature uniformity over the whole length and also to enable preheating of the incoming gas if required. The three heating zones consist of the mantle, top and bottom heater. The mantle heater is designed for the highest mechanical stability. An optional metallic retort can be specified to protect the heating elements should any outgassing of the sample occur and improve the temperature uniformity.

To insulate the heat in metallic furnaces, tungsten or molybdenum radiation shields are used. The HBO has a double walled, water cooled vessel. The sample holder is positioned as required.

Each of the three heating zones are individually controlled and protected by an additional over-temperature protection thermocouple; therefore, unattended operation is possible. An optional fast cooling system significantly reduces the cool down time.

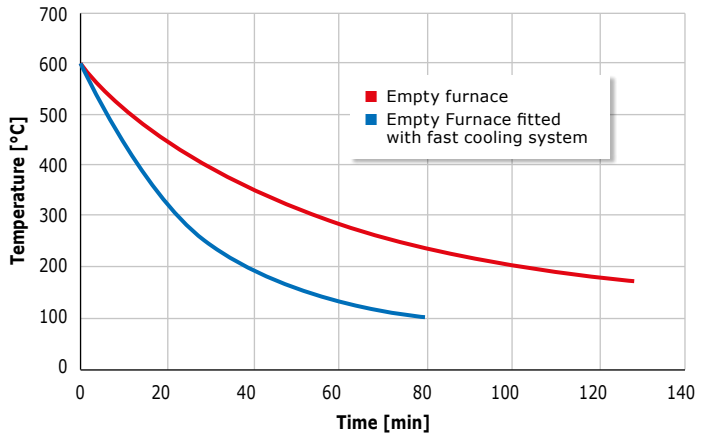

Cooling down to room temperature

The graph shows the cool down curves for an empty furnace (red) and an empty furnace fitted with the fast cooling system (blue), both with a usable volume of 60 l. By using a fast cooling system, the cool down time of the empty furnace is reduced approximately by a factor of two.

View inside



Heating element



Charging rack

- 1 gas inlet or outlet
- 2 gas outlet or inlet
- 3 pumping unit attached from below
- 4 location of the thermocouple
- 5 radiation shields
- 6 heating elements
- 7 water cooled vessel
- 8 sample holder (built on request)

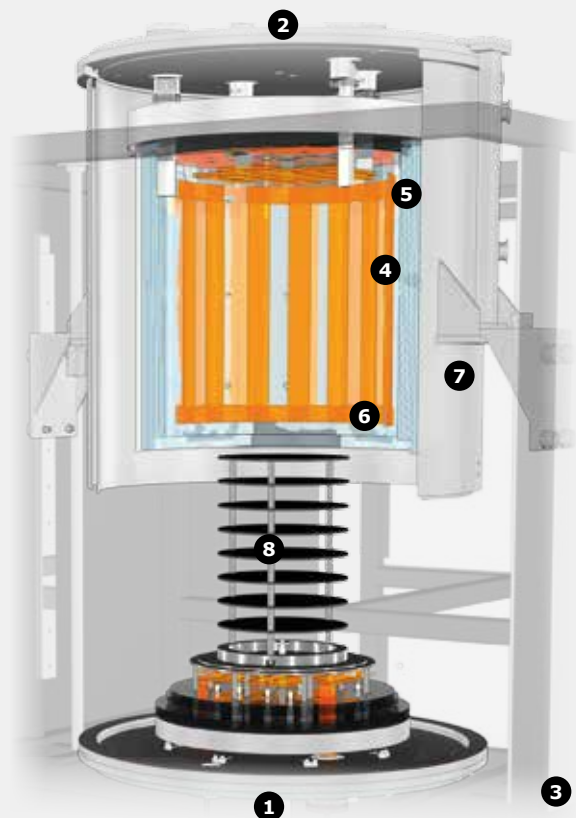

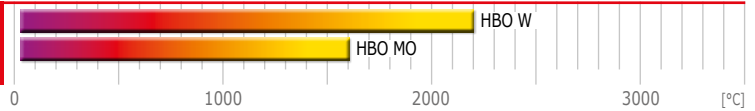

Options

Available options include customized vacuum pumping systems, operational software systems, multiple gas inlets, reactive or inert gas systems, and water cooling systems when an adequate water supply is not available on site. The HBO is equipped with an automatic software system.

Vacuum System:

The HBO models can be equipped with a pre-pump for pre-vacuum operation. For fine vacuum operation, a pre-pump is used in tandem with a roots pump. A pre-pump is combined with a turbomolecular pump for high vacuum operation. The following turbomolecular pumps are recommended for the furnaces of different sizes:

- HBO 10: Pump with a pumping speed of 300 or 400 l/s
- HBO 25: Pump with a pumping speed of 400 or 700 l/s
- HBO 60: Pump with a pumping speed of 700 or 1200 l/s

The turbomolecular pumps, with higher pumping speeds, reduce the pump down time and result in a better final vacuum. The pre-pumps are two stage rotary vane pumps. Other pump options are available upon request.

Software:

The software operation of the HBO is done automatically. The system is operated by use of the TP 1900 software or WinCC via a touch panel interface for ease-of-use and visualization of the process. With WinCC, the operation of the touch screen provides more options.

With both software systems, a csv file can be generated for later evaluations.

- TP 1900: 20 different heat programs can be stored. Each consisting of up to 25 different segments.
- WinCC: 50 different heat programs can be stored. Each consisting of up to 30 different segments.

Reaction gas equipment:

If Hydrogen is used in a mixture of more than 4%, the furnace will be equipped with an afterburner with heated gas outlet to prevent any formation of condensation. Upon request, more than one inert gas can be integrated into the furnace. A retort can be installed to protect the heating elements and ensure a defined gas flow through the furnace.

- Reaction gas equipment
- More than one inert gas
- Retort

Water cooling:

If on-site water cooling is unavailable, a cooling system may be ordered. The cooling power will be designed to meet the requirements of the furnace and on-site power availability.

- Water cooling system: Chiller

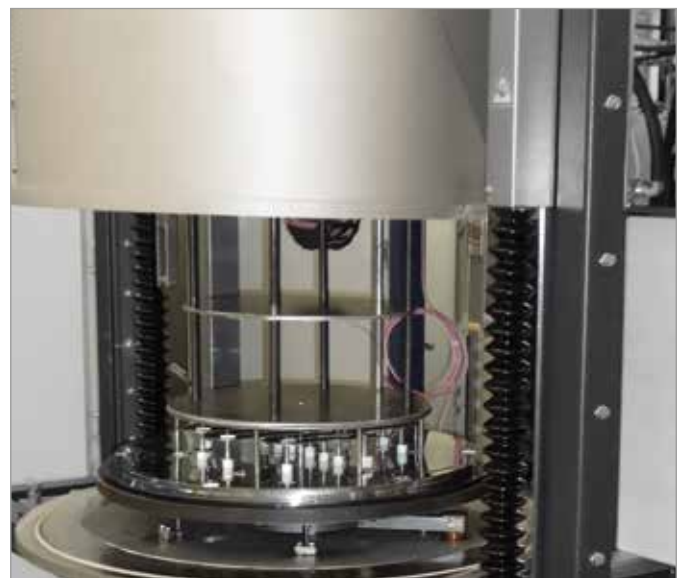

The HBO, as shown, illustrates the easy access to the sample area. Sample holders are available upon request.

Application Example

Soldering and brazing of electronic components



A popular application for the HBO is vacuum soldering and brazing. Many electronic components used for satellites, airplanes, radar, or laser tubes need to be soldered and brazed in a high vacuum environment. Due to the superior vacuum capability, the HBO is best suited for this application. The HBO is an ideal choice for adhering dissimilar material by soldering and brazing. In addition to the excellent vacuum, the hood moves upward allowing the sample to remain stationary in order to avoid any harmful vibrations to the sample. The hood movement is automatically controlled.

The programming software, with its precise data logging, ensures that the process can be controlled, evaluated, and improved. All operational data are logged at predefined time intervals and can be easily exported to a csv file.

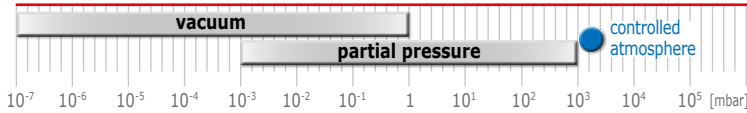

HBO – Hood Furnaces up to 2200 °C

Technical data

Model	Molybdenum			Tungsten		
	HBO 10 MO/16-1G	HBO 25 MO/16-1G	HBO 60 MO/16-1G	HBO 10 W/22-1G	HBO 25 W/22-1G	HBO 60 W/22-1G

External dimensions

H x W x D [mm]	2500 x 2300 x 2000	2500 x 2300 x 2000	2800 x 2300 x 2500	2500 x 2300 x 2000	2500 x 2300 x 2000	2800 x 2300 x 2500
----------------	--------------------	--------------------	--------------------	--------------------	--------------------	--------------------

Transport weight

Complete system [kg]	1800	2000	3000	1800	2000	3000
----------------------	------	------	------	------	------	------

Usable space

Volume [l]	10	25	60	10	25	60
∅ x H, usable space without retort [mm]	200 x 300	300 x 400	400 x 500	200 x 300	300 x 400	400 x 500
∅ x H, usable space with retort [mm]	180 x 280	280 x 380	380 x 480	180 x 280	280 x 380	380 x 480

Thermal values

T _{max} vacuum [°C]	1600	1600	1600	2200	2200	2200
T _{max} atmospheric pressure [°C]	1600	1600	1600	2200	2200	2200
ΔT, above 800 °C [K] (according to DIN 17052)	± 10	± 10	± 10	± 10	± 10	± 10
Max. heat-up rate [K/min]	10	10	10	10	10	10
Cooling time [h]	3	4	5	4	5	6

Connecting values

Power [kW]	50	65	80	125	150	250
Voltage [V]	400 (3P)	400 (3P)	400 (3P)	400 (3P)	400 (3P)	400 (3P)
Current [A]	3 x 125	3 x 100	3 x 120	3 x 180	3 x 220	3 x 380
Series fuse [A]	3 x 160	3 x 125	3 x 160	3 x 250	3 x 315	3 x 500

Vacuum (option)

Leakage rate (clean, cold and empty) [mbar l/s]	< 5 x 10 ⁻³			< 5 x 10 ⁻³		
Vacuum range depending on the pumping unit	rough, fine, high or ultra high vacuum			rough, fine, high or ultra high vacuum		

Cooling water required

Flow [l/min]	40	50	64	100	120	200
--------------	----	----	----	-----	-----	-----

Gas supply

Nitrogen or Argon flow, others on request [l/h]	500-2000	500-2000	500-2000	500-2000	500-2000	500-2000
---	----------	----------	----------	----------	----------	----------

Controller

Controller	Siemens			Siemens		
------------	---------	--	--	---------	--	--

**HB – Hood Furnaces
up to 1800°C**

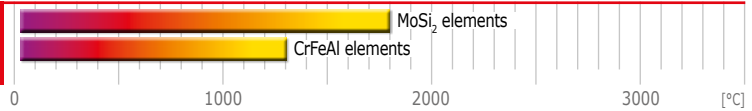

**High temperature hood furnaces
for heat treatment in air**

The HB series is a furnace with an automatically movable hood.

Samples are accessible from all sides with the movable hood design of the HB series. The HB can be equipped with CrFeAl heating wires or with MoSi₂ heating elements for the highest temperatures.

The HB hood furnaces are available with usable volumes of 80 or 160 litres. The inner space is rectangular in design. The hood moves up and down automatically to load and unload the sample. The base plate has a convenient height of 750 mm. The HB series can be equipped with CrFeAl wires for heat treatment applications up to 1300°C.

Alternatively, the furnace can be equipped with MoSi₂ heating elements for a maximum temperature of 1600°C, 1700°C or 1800°C. Both heating elements need to be oxidized to guarantee their reliable functionality. Every HB is carefully engineered to provide the best temperature uniformity possible.

The HB is not a completely sealed system. Nevertheless, it is possible to adapt a gas inlet system by means of a rotameter and valve. By purging the furnace, the Oxygen level is reduced to ~50 ppm.

The temperature is controlled by a type S thermocouple, which is inserted into a ceramic protection tube. For unattended operation, an over-temperature thermocouple with a controller is recommended.

All debinding applications require an afterburner that will be installed onto the furnace. The afterburner is driven by propane gas and compressed air to combust any evaporating binder. Carbolite Gero specializes in custom furnaces and can also create a custom version of the HB to accommodate your heat treatment needs. It is possible to equip a gas circulating system to improve temperature uniformity. Several sample thermocouples can be inserted into the furnace chamber to monitor and test the temperature profile. Through the use of a serial interface, the thermocouple data is logged at predefined intervals for evaluation. The furnace is operated manually with a Eurotherm controller. Other controllers are available upon request.



HB 13/80:
High temperature hood furnace with a usable volume of 80 l up to 1300°C. Operation under air or slightly modified atmosphere is possible.

Advantages

- Sintering up to 1800°C in air
- Debinding in air with the debinding package
- High performance ceramic fibre insulation
- Uniform temperature distribution
- High sample accessibility, hood design
- Data recording option

Typical applications

Debinding and sintering in air, drying, annealing, tempering, degassing, sintering, debinding, synthesis, sublimation, drying, CIM

Application Example

Heat treatment for the production of superconductors



For the heat treatment of some superconductors, a reduced Oxygen atmosphere is required. The temperature uniformity is critical as the temperature must be highly uniform over the entire sample. For such an application, the HB is equipped with a circulation ventilator and sample thermocouples. Superconductors lose their electrical resistance when a certain transition temperature is underrun. A huge current flow is possible and a high magnetic field is generated when superconductors are undergo proper heat treatment.

Levitating superconductor due to the compensation of the magnetic field inside of a superconductor.

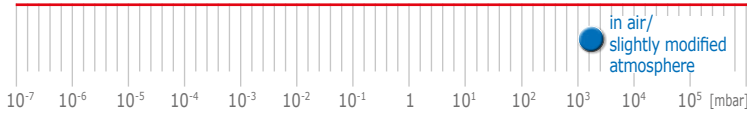

View inside



Picture inside the hood of the HB equipped with CrFeAl heating elements for a maximum temperature of 1300°C.

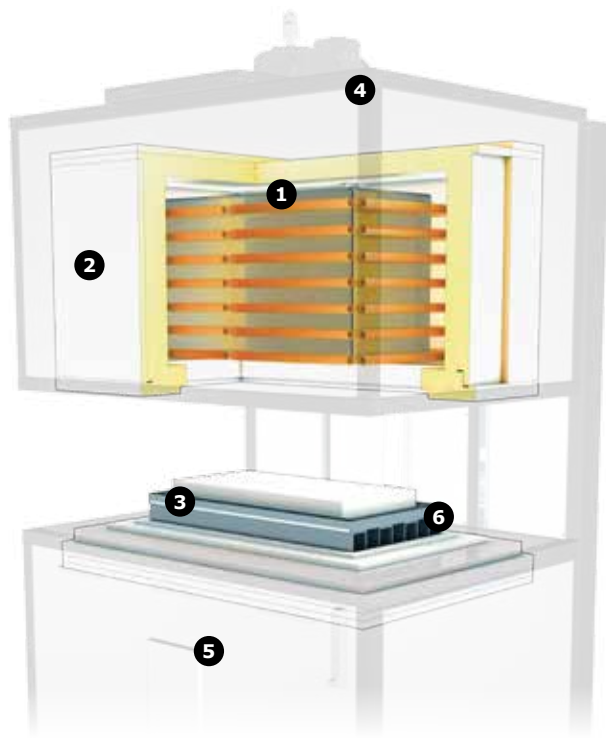

- 1** heating elements
- 2** ceramic fibre insulation
- 3** bottom plate in 750 mm height
- 4** automatic moving hood
- 5** location of the rotameter
- 6** bottom heater only for CrFeAl heating elements

Options

The HB can be equipped with a debinding unit or with an additional gas supply

- Afterburner
- Additional gas inlet with valve and rotameter

Software:

Manual furnaces are operated by Eurotherm controllers in combination with the KP 300 panel. Valves and pumps are operated by simple push buttons on the panel. For data logging purposes, iTools software and PC connectivity are available.

Technical data

	Ceramic fibre	
 Model	 HB 18/80	 HB 18/160

External dimensions

H x W x D [mm]	2200 x 1200 x 1200	2200 x 1800 x 1200
-----------------------	--------------------	--------------------

Transport weight

Complete system [kg]	1000	1250
-----------------------------	------	------

Usable space

Volume [l]	80	160
H x W x D, usable space without retort [mm]	500 x 400 x 400	500 x 800 x 400

Thermal values

T_{max} atmospheric pressure [°C]	1300, 1600, 1700, 1800	1300, 1600, 1700, 1800
ΔT, between 800°C and T_{max} [K] (DIN 17052)	±5	±5
Max. heat-up rate [K/min]	5, 10, 10, 10	5, 10, 10, 10
Cooling time [h]	12, 14, 14, 14	14

Connecting values

Power [kW]	15, 45, 50, 60	30, 80, 85, 90
Voltage [V]	400 (3P)	400 (3P)
Current [A]	3 x 25, 3 x 65, 3 x 72, 3 x 86	3 x 50, 3 x 115, 3 x 123, 3 x 130
Series fuse [A]	35, 100, 100, 125	63, 160, 160, 200

Controller

Controller	on request
-------------------	------------

- Eurotherm 3508: 10 different storable programs with 500 different segments.
- Eurotherm 3508: 50 different storable programs with 500 different segments.
- RS 232/485
- iTools OPTION
- Over-temperature protection option (recommended for continuous and unattended use)
- Remote control

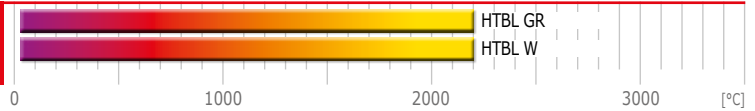

Bottom loading furnaces

The HTBL is a bottom loading furnace system that is based on graphite or metallic insulation and heating elements.

Graphite furnaces offer temperatures of 2200°C or 3000°C upon request. Graphite models of the HTBL are offered in volumes of 50, 80 and 200 litres. The metallic furnaces are offered with a volume of 60 litres. The HTBL 60 MO/16-1G has a maximum temperature of 1600°C and uses molybdenum radiation shields and heating elements. The HTBL 60 W/22-1G has a maximum temperature of 2200°C and uses tungsten radiation shields and heating elements. The metallic versions of the HTBL are suited for generating the purest atmospheres and the best working vacuum level.

One clear advantage is the easy loading and unloading of the HTBL type furnaces. Once the hearth has been lowered, the sample is accessible from all sides without limitations. Sample loading is extremely easy and user-friendly, especially with delicate samples. Additionally, sample thermocouples can be placed at specified locations within the chamber. A retort may also be used with the HTBL. The movement of the loading area is fully automated and driven by a hydraulic arm. Once the loading area has reached the lowest position, the user can manually rotate the loading platform outward by 90°.

Nitrogen, Argon, and Hydrogen gases are available for use as either pure or mixed gas. Other gases may be installed upon request. A slight overpressure or controlled partial pressure, to establish a defined gas flow, can be used in the furnace. Operation with air is not possible.

Various dosing and controlling devices control all gases. Depending on the vacuum requirements, vacuum pumps are configured specifically for the application or as requested. The temperature is independently controlled to achieve the best uniformity.



HTBL 60 GR/22: Bottom loading furnace with a usable volume of 60 l up to 2200°C. The bottom loading area is expanded for full accessibility.

Advantages

- Metallic furnaces provide precisely defined atmospheres with the highest possible purity (6 N or better)
- Graphite furnaces offer the highest possible temperatures
- Hydrogen partial pressure operation upon request
- Precisely controlled vacuum pumping speeds appropriate for use with powders
- Fully automatic operation
- Data recording for quality management

Typical applications

Hardening, annealing, tempering, quenching, soldering, brazing, degassing, pyrolysis, siliconization, carbonisation, rapid prototyping, sintering, debinding, synthesis, sublimation, drying, MIM, CIM

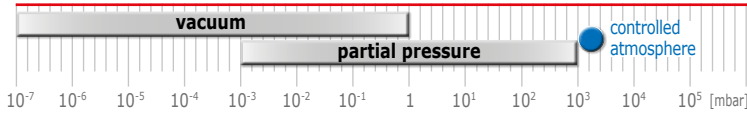

Technical details

The HTBL GR has one heating zone made from graphite. The mantle heater is software controlled and provided with a controller and thermocouple dedicated for over-temperature protection. The mantle heater consists of several graphite rods arranged along the cylindrical hearth that are secured to the top of the chamber. The insulation of this system consists of graphite felt. The system is surrounded by a water cooled vessel. To load and unload the furnace, locking clamps are manually operated. Vacuum tubes must also be attached and detached manually. Aside from these two steps, all remaining movements of the furnace hearth are fully automated. After the bottom, loading area has reached the lowest position, the user can rotate the platform outward by 90°. The automated features of the HTBL are ideal for large scale production.

The graphite based HTBL is equipped with a pyrometer and a sliding thermocouple. A retort can be supplied on request. Graphite is a very versatile construction material for high temperature furnaces. However, if the sample is sensitive to carbon, a metallic furnace must be used.

The HTBL based on metallic materials is also equipped with one heating zone (mantle heater) made from tungsten or molybdenum. The radiation shields that provide the heat insulation are constructed of the same material as the heating elements. Standard systems use nine radiation shields surrounding the heating elements. If a lower maximum temperature is required, it is possible to reduce the number of radiation shields. The HTBL, with a diameter of 400 mm and heated length of 500 mm, is well suited for high vacuum processes. Both molybdenum and tungsten exhibit very low vapor pressure even at the highest temperatures. Once the maximum temperature is achieved, the heating elements must be handled with care as they will become brittle.

All HTBL models are equipped with fully automated software and reliable data logging for later evaluation of the process. All process data are measured and logged at predefined intervals. Automated control and high volume units are especially suited for industrial applications and large scale production.

View inside



Picture of the mantle heater made from graphite. It consists of several graphite rods, which are arranged symmetrically to ensure a uniform temperature distribution.

- 1** heating elements
- 2** water cooled current feedthrough
- 3** bottom locking device
- 4** frame
- 5** bottom plate

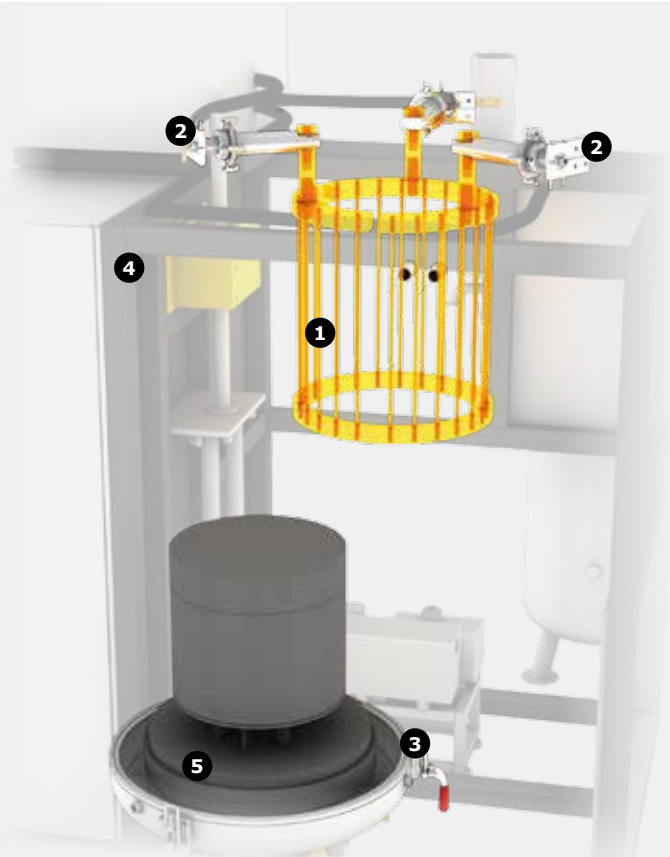

HTBL – Bottom Loading Furnaces up to 2200 °C

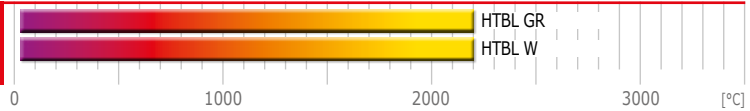

Options

Available options include customized vacuum pumping systems, operational software systems, multiple gas inlets, reactive or inert gas systems, and water cooling systems when an adequate water supply is not available on-site. The HTBL is equipped with a programmable software system for automated operation. Additional heating zones can be installed upon request.

Vacuum System:

HTBL models can be equipped with a pre-pump for pre-vacuum operation. For fine vacuum operation, a pre-pump will be used in combination with a roots pump. For high vacuum operation, the pre-pump is combined with a turbomolecular pump or oil diffusion pump. For the HTBL 200 GR/22-1G, the oil diffusion pump is recommended due to the high pumping speed. For fast evacuation of large volumes, the oil diffusion pump is always recommended. The high vacuum pump system is configured for the furnace size based on the following pumping speeds:

- Turbomolecular pumps run at a pumping speed of 1200 or 1500 l/s
- Oil diffusion pumps run at a pumping speed of 8000 m³/h

Software:

Software operation of the HTBL is performed by TP 1900 software or WinCC via a user friendly touch panel interface that is intuitive and provides visualization of the thermal process. WinCC operation features more options that are visually represented on the touch screen interface. With both software systems, a csv file can be generated for later evaluations.

- TP 1900: 20 different heat programs can be stored, each consisting of up to 25 different segments.
- WinCC: 50 different heat programs can be stored, each consisting of up to 30 different segments.

Reaction gas equipment:

If Hydrogen is used in a mixture of more than 4%, the furnace will be equipped with an afterburner with heated gas outlet to prevent any formation of condensation. Upon request, more than one inert gas can be integrated into the furnace. A retort can be installed to protect the heating elements and ensure a defined gas flow through the furnace.

- Reaction gas equipment
- Safety package for combustible gases
- Debinding unit with active flame for combustion
- More than one inert gas
- Retort

Water cooling:

If on-site water cooling is unavailable, a cooling system may be ordered. The cooling power will be designed to meet the requirements of the furnace and on-site power availability.

- Water cooling system: Chiller

Application Example
Siliconization



Carbon-fibre-reinforced ceramic-matrix composites draw a great deal of attention for use in a broad range of applications. In highly oxidizing atmospheres and very high temperatures, C/C – SiC composites are ideal materials for these environments due to advantageous properties, such as high thermal stability, high thermal conductivity, low density, and high abrasion. Common applications for these composites are for use in jet vanes for missile rockets, brake pads for sport cars, bullet proof vests, and nose capes for spacecraft (atmospheric reentry). One major manufacturing process is the liquid silicon infiltration (LSI) of porous C/C, which can be accomplished in the HTBL GR. Compared to other processes such as chemical vapor infiltration, LSI is a cost effective and quick manufacturing process. During heat treatment, silicon is melted on top of a porous C/C substrate and diffuses into the pores of the material. A carbon matrix with silicon, SiC, results from this reaction. The final product results in a dense material with C/C segments separated from each other by SiC.

For this process, the graphite based HTBL is well suited. The programmable software allows unattended operation possible and ensures proper data logging.

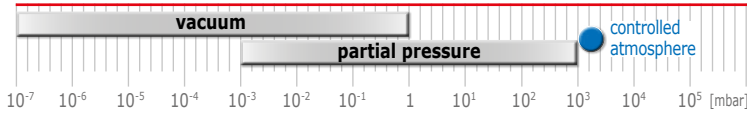

Technical data



Model

	Graphite				Molybdenum	Tungsten
	HTBL-H 50 GR/22-1G	HTBL 50 GR/22-1G	HTBL 80 GR/22-1G	HTBL 200 GR/22-1G	HTBL 60 MO/16-1G	HTBL 60 W/22-1G

External dimensions

H x W x D [mm]	4300 x 2400 x 2200	3500 x 2400 x 2200	4300 x 2400 x 2200	4800 x 2400 x 2600	3300 x 2400 x 2200	3300 x 2400 x 2200
-----------------------	--------------------	--------------------	--------------------	--------------------	--------------------	--------------------

Transport weight

Complete system [kg]	3200	3200	3500	4200	3400	3600
-----------------------------	------	------	------	------	------	------

Usable space

Volume [l]	50	50	80	200	60	60
Ø x H, usable space without retort [mm]	300 x 700	400 x 400	400 x 700	500 x 900	400 x 500	400 x 500
Ø x H, usable space with retort [mm]	280 x 680	380 x 380	380 x 680	480 x 880	380 x 480	380 x 480

Thermal values

T_{max} vacuum [°C]	2200	2200	2200	2200	1600	2200
T_{max} atmospheric pressure [°C]	2200	2200	2200	2200	1600	2200
ΔT, between 500 °C and 2200 °C [K] (according to DIN 17052)	± 10	± 10	± 10	± 10	± 10	± 10
Max. heat-up rate [K/min]	10	10	10	10	10	10
Cooling time [h]	8	8	12	16	5	6

Connecting values

Power [kW]	120	120	200	300	80	250
Voltage [V]	400 (3P)	400 (3P)	400 (3P)	400 (3P)	400 (3P)	400 (3P)
Current [A]	3 x 175	3 x 175	3 x 290	3 x 430	3 x 115	3 x 360
Series fuse [A]	3 x 250	3 x 250	3 x 400	3 x 630	3 x 160	3 x 500

Vacuum (option)

Leakage rate (clean, cold and empty) [mbar l/s]	< 5 x 10 ⁻³				< 5 x 10 ⁻³	< 5 x 10 ⁻³
Vacuum range depending on the pumping unit	rough or fine vacuum				rough, fine, high or ultra high vacuum	rough, fine, high or ultra high vacuum

Cooling water required

Flow [l/min]	100	100	150	220	64	200
---------------------	-----	-----	-----	-----	----	-----

Gas supply

Nitrogen or Argon flow, others on request [l/h]	500-2000	500-2000	500-2000	500-2000	500-2000	500-2000
--	----------	----------	----------	----------	----------	----------

Controller

Controller	Siemens				Siemens	Siemens
-------------------	---------	--	--	--	---------	---------

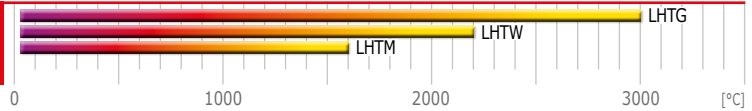

High temperature laboratory furnaces

The unique feature of the LHT high temperature laboratory furnace series is a compact design, making it the perfect tool for laboratories in research and development environments.

The LHT series consists of the LHTG, LHTW, and LHTM with usable space having a diameter of 100 mm and heated height of 200 mm or a diameter of 200 mm and heated height of 300 mm. The cylindrical usable space is surrounded by the heating elements and insulation material. The heated chamber is integrated into the water cooled vessel. As a result of the small volume, the LHT is ideal for small samples and requires minimal operating space. The system is supported by a single frame platform which supports the furnace and electronic cabinet containing the software controls. Casters are attached to the supporting platform, which allows the whole system to move easily. For universities and industrial research laboratories, the LHT series is a perfect fit for such operating areas.

The small overall dimensions and simple operation result in a cost effective system without any performance loss in temperature uniformity or atmospheric quality. Additionally, the cylindrical design is best suited for overpressure heat treatment processes. Upon request, the system can be equipped with a suitable locking device and all necessary equipment for safe overpressure operations up to 100 bar.

The LHTG has heating elements and insulation material made from graphite. Graphite based LHT models are temperature controlled by pyrometers. An over-temperature thermocouple can be added as an option, which is highly recommended for unattended operation. Under Argon environment, the maximum temperature is 3000°C, which requires the use of a pyrometer to measure the chamber temperature. The pyrometer is combined with the use of a sliding thermocouple to measure temperatures at the beginning of the process as the initial temperatures are not high enough to be detected by the pyrometer.

The metallic LHT models are based on heating elements and radiation shields constructed of tungsten or molybdenum for a maximum temperature of 2200°C and 1600°C, respectively. The radiation shields serve to insulate the heat of the heating elements from the water cooled vessel. The metallic LHT systems provide the highest possible atmospheric purity and best final vacuum level. With a turbomolecular pump in combination with a pre-pump, the working vacuum can reach the high vacuum region. An ultra high vacuum configuration is possible upon request.



LHTW 200-300/22: High temperature laboratory furnaces with a diameter of 200 mm and a heated height of 300 mm up to 2200 °C.

Advantages

- Compact design suited for laboratories
- Best possible vacuum
- Vacuum level $< 5 \times 10^{-6}$ mbar
- Partial pressure 10 – 1000 mbar
- Overpressure operation up to 100 bar possible
- High temperature top loader up to 3000 °C with Graphite
- Hydrogen partial pressure operation on demand
- Precisely controlled vacuum pumping speeds appropriate for use with powders
- Data recording for quality management

Typical applications

Hardening, annealing, tempering, quenching, soldering, brazing, degassing, pyrolysis, siliconization, carbonisation, rapid prototyping, sintering, debinding, synthesis, sublimation, drying, MIM, CIM

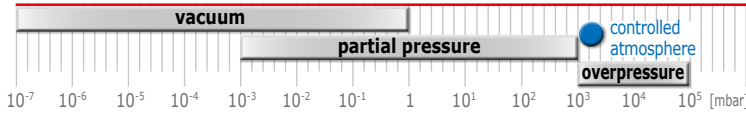

Technical details

LHT models are heated by a single mantle heater because of their small volume. The temperature profile inside is better than ±10K. This uniformity is achieved through careful engineering and positioning of the heating element. The LHTG is based on graphite heating elements and insulation material. If the highest temperature of 3000°C is required, the insulation thickness and the graphite insulation layers must be specifically designed to withstand the extreme temperatures. The installed power must also be adapted to reach 3000°C with a high heating rate. The heating cassette is surrounded by a water cooled vessel. The furnace is equipped with all necessary flanges, thermocouples, electrical connections and the pyrometer. The vessel is double walled and water cooled for safety. Electrical connections and electrical cables are water cooled as well.

The LHTM and LHTW are both constructed of metallic materials and 9 radiation shields. It has a single heating zone that covers the mantle of the cylindrical vessel. The mantle heater is designed for the highest stability. Two different heating elements are available. The standard heating elements consists of several molybdenum sheets, and upon request, a mesh heater is also available. The sample can be protected by a retort that further improves temperature uniformity. With the adaption of a high vacuum system, the best final vacuum is available.

Software operation is available with manual or automated controls. For the manual version, all valves and pumps are operated by simple push buttons at the user panel with a rotameter used to adjust gas flow. The automated software is operated via a touch panel interface. Mass flow controllers are used to regulate the gas flow. Data logging is possible for both manual and automated operation.

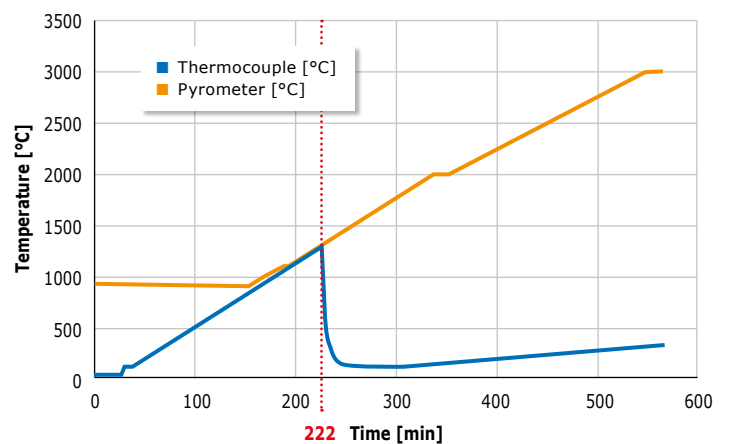

The graph shows a typical heat up curve of the LHTG. Beginning from room temperature, the sliding thermocouple (blue curve) shows the temperature inside the furnace. After approximately 222 minutes, the thermocouple is automatically moved out of the furnace, and the pyrometer begins to monitor the temperature. The system is heated up by 5 K/min up to 3000°C.

View inside



A mesh heater is available upon request



Mantle heater made from metallic material

- 1 water cooled vessel
- 2 heating elements
- 3 top cover, manually operated
- 4 thermocouple
- 5 radiation shields at the top
- 6 radiation shields at the mantle
- 7 short circuit ring

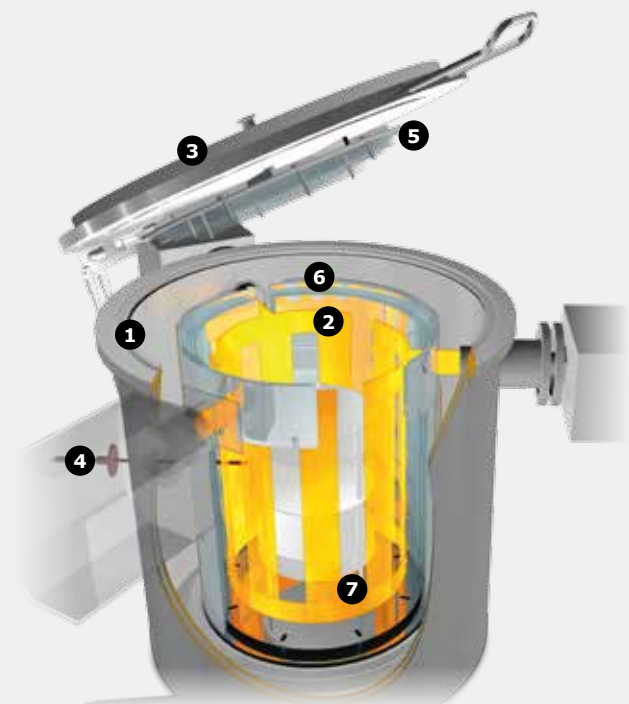

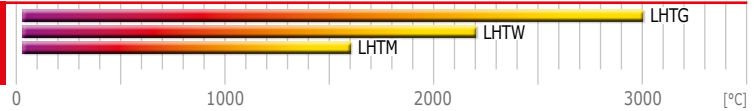

Options

All LHT models are available with manual or automated controls. Different pumping units, software systems, or additional reactive or inert gases can be configured for the system. Overpressure up to 100 bar is an available option as well as a water cooling system when adequate water supply is not available on-site.

Vacuum System:

The LHT models can be equipped with a pre-pump for pre-vacuum operation. For fine vacuum operation, a pre-pump combined with a roots pump is required. For high vacuum operation, a pre-pump in combination with a turbomolecular pump is recommended.

The following turbomolecular pump is recommended for the LHTM:

- A turbomolecular pump with a pumping speed of 300 l/s

The turbomolecular pumps, with higher pumping speeds, are available upon request.

Pre-pumps are two stage rotary vane pumps.

Other pumps are available upon request.

Software:

TP 1900 software or WinCC are the available options for automated programming. A touch panel interface and data logging operation is available for both software versions and allow visualization of the process. WinCC includes additional operations via the touch panel interface.

- TP 1900: 20 different heat programs can be stored. Each consisting of up to 25 different segments.
- WinCC: 50 different heat programs can be stored. Each consisting of up to 30 different segments.

Manual furnaces are operated by Eurotherm controllers in combination with a KP 300 Panel. Valves and pumps are operated by simple push buttons on the panel. For data logging purposes, iTools software and PC connectivity are available.

- Eurotherm 3508: 10 different storable programs with 500 different segments.
- Eurotherm 3508: 50 different storable programs with 500 different segments
- RS 232/485
- iTools OPTION
- Over-temperature protection option (recommended for continuous and unattended use)
- Remote control

Reaction gas equipment:

For Hydrogen use greater than 4%, the furnace must be equipped with an afterburner. The gas outlet can also be heated to prevent possible condensation. Upon request, more than one inert gas can be attached to the furnace. A retort can also be installed to protect the heating elements or to ensure a defined pathway for gas flow.

- Reaction gas equipment
- Safety package for combustible gases
- Debinding unit with active flame for combustion
- More than one inert gas
- Retort

LHT model equipped with the reaction gas equipment including all safety provisions.



Application Example

Carbon Nanotubes (CNT)

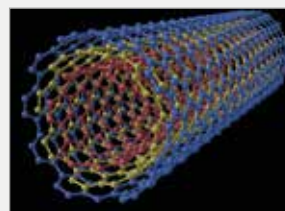

Because the LHT is offered as either a metallic system or a graphite system, the application range of the LHT is very versatile. A typical application example of the LHTG is carbon nano tube synthesis.

The graphite based LHT models enable temperatures up to 3000°C. Provided that carbon is not harmful to the sample or that the sample consists of carbon, the LHTG is ideal for the heat treatment process. A popular modern carbon based material are carbon nano tubes or CNTs. CNTs are cylindrical tubes consisting of carbon atoms with an inner diameter less than 0.9 nm. CNTs are the focus of research and development as the mechanical stability and electrical transport properties are outstanding. Additional application include use as field emitters with high angular current emission, fillers in composite fabrication, or nanoscale bearings. The aforementioned materials are stable up to 2000°C, and heat treatment processes are used for the removal of structural defects such as metallic impurities and vacancies. Heat treatment can also change the structure itself from a single wall carbon nano tube (SWNT) to a double walled carbon nano tube (DWNT) or even to a multi walled carbon nano tube (MWNT). Both DWNTs and MWNTs are much more stable compared to the SWNT. Those structural changes occur at a temperature between 2000°C and 2800°C in an Argon atmosphere. Therefore, the LHTG is the furnace of choice for the heat treatment of carbon nanotubes.

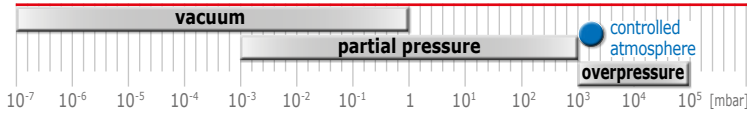

LHT – Laboratory Furnaces up to 3000 °C

Technical data



Model

	Graphite				Molybdenum		Tungsten	
	LHTG 100-200/22-1G	LHTG 100-200/30-1G	LHTG 200-300/22-1G	LHTG 200-300/30-1G	LHTM 100-200/16-1G	LHTM 200-300/16-1G	LHTW 100-200/22-1G	LHTW 200-300/22-1G

External dimensions

H x W x D [mm]	1800 x 1900 x 1000				1800 x 1900 x 1000		1800 x 1900 x 1000	
-----------------------	--------------------	--	--	--	--------------------	--	--------------------	--

Transport weight

Complete system [kg]	780	1000	900	1500	800	950	850	1000
-----------------------------	-----	------	-----	------	-----	-----	-----	------

Usable space

Volume [l]	1.5	1.5	10	10	1.5	10	1.5	10
Ø x H, usable space without retort [mm]	100 x 200	100 x 200	200 x 300	200 x 300	100 x 200	200 x 300	100 x 200	200 x 300
Ø x H, usable space with retort [mm]	90 x 200	90 x 200	180 x 300	180 x 300	90 x 200	180 x 300	90 x 200	180 x 300

Thermal values

T_{max} vacuum [°C]	2200	2200	2200	2200	1600	1600	2200	2200
T_{max} atmospheric pressure [°C]	2200	3000	2200	3000	1600	1600	2200	2200
ΔT, between 500 °C and 2200 °C [K] (according to DIN 17052)	± 10	± 10	± 10	± 10	± 10	± 10	± 10	± 10
Max. heat-up rate [K/min]	10	20	10	20	10	10	10	10
Cooling time [h]	4	5	5	7	2.5	4	3	5

Connecting values

Power [kW]	22	40	45	85	22	45	45	90
Voltage [V]	400 (3P)	400 (3P)	400 (3P)	400 (3P)	400 (3P)	400 (3P)	400 (3P)	400 (3P)
Current [A]	3 x 55	3 x 100	3 x 65	3 x 120	3 x 55	3 x 65	3 x 112.5	3 x 130
Series fuse [A]	3 x 63	3 x 125	3 x 80	3 x 160	3 x 63	3 x 80	3 x 160	3 x 160

Vacuum (option)

Leakage rate (clean, cold and empty) [mbar l/s]	< 5 x 10 ⁻³				< 5 x 10 ⁻³		< 5 x 10 ⁻³	
Vacuum range depending on the pumping unit	rough or fine vacuum				rough, fine, high or ultra high vacuum		rough, fine, high or ultra high vacuum	

Cooling water required

Flow [l/min]	20	30	50	75	30	50	50	75
Max. inlet temperature [°C]	23	23	23	23	23	23	23	23

Gas supply

Nitrogen or Argon flow, others on request [l/h]	50-500	50-500	50-500	50-500	50-500	50-500	50-500	50-500
--	--------	--------	--------	--------	--------	--------	--------	--------

Controller

Manual operation	Eurotherm with KP 300 panel				Eurotherm with KP 300 panel		Eurotherm with KP 300 panel	
Automatic operation	Siemens				Siemens		Siemens	

BV-HTRV – Bridgman Crystal Growth Furnaces up to 1800 °C

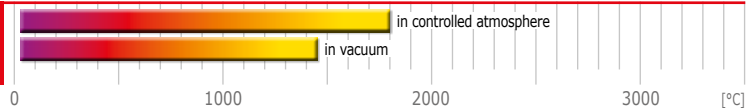

Tube furnaces for crystal growing according to the Bridgman method

With the HTRV tube furnace series mounted vertically on a supporting unit, crystals can be grown using the Bridgman method.

The Bridgman method uses a pre-synthesized material that moves slowly through a temperature gradient. The melted material moves through a decreasing temperature gradient and forms a single crystal. The BV-HTRV is a tube furnace which is mounted on a device engineered specifically for the Bridgman method. As a standard, the HTRV 70-250 or the HTRV 100-250 are used as a tube furnace mounted on the pulling device. In principal, every tube furnace can be mounted on the pulling device. Most common are the two models, HTRV 70-250 and the HTRV 100-250. The short heated length is an advantage as it creates an ideal gradient for the Bridgman method. The temperature decreases towards the bottom of the furnace. The pulling device moves the sample with an adjustable speed toward the lower temperature. Next to the sample is a thermocouple in order for an accurate reading of the sample temperature. Both, sample and probe thermocouple are attached to the bottom pulling device. The movement of the sample can be fast for loading and unloading or with a user defined speed for crystal growth. A ceramic tube surrounds the probe thermocouple and sample. At both ends of the tube, a water cooled flange is connected. At the top of the system, the tube and flange are fixed. A bellow connects the tube and pulling device at the bottom of the furnace. The bellow is extended during the downward movement of the sample. Operation of the unit can be achieved under vacuum conditions.

At the top, the tube is connected to the vacuum pump. The valve towards the vacuum line is opened and closed manually. The vacuum level is controlled by a piezo measurement gauge. A manually operated rotameter allows purging of inert gas. To reduce the Oxygen value prior to the crystal growing process, evacuation and backflowing with an inert gas is performed several times. It is possible to connect a computer to the system in order to log all the relevant data of the process, i.e. position of the sample and temperature of the probe thermocouple. To load and unload the sample, the clamps must be opened. With the fast moving option, the sample is easily accessible.

The pulling device that enables Bridgman type crystal growth can be combined with all single and multi-zone tube furnaces.



BV-HTRV 70-250/18: Bridgman crystal growth furnace with a heated length of 250 mm up to 1800°C. The system is equipped with a pre vacuum pump.

Advantages

- Bridgman method – Crystal growing
- In vacuum up to 1450°C
- In an inert atmosphere up to 1800°C
- Precisely defined and controlled pulling speed
- Manual operation
- Data recording option

Typical applications

Growing of single crystals, Bridgman method

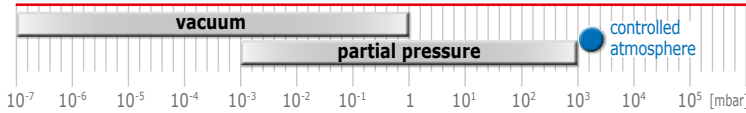

BV-HTRV – Bridgman Crystal Growth Furnaces up to 1800°C

Technical details

The HTRV tube furnace includes heating elements of MoSi₂ that are mounted in a vertical, hanging position and are surrounded by vacuum formed plates to insulate the heat from the housing. The housing is slotted to enable convection cooling of the casing. Depending on the melting point of the sample, the maximum temperature is designed up to 1600°C, 1700°C, or 1800°C. For the pulling device, two motors with different transmission ratios are implemented. For instance, the fast moving of the samples is possible with a speed of approximately 10 mm/s, whereas the Bridgman crystal growing process, the pulling speed is only 0.00001 mm/s (10 nm/s). All connecting tubes of the lower water cooled flange are inserted in a drag chain. The control thermocouple is a type B thermocouple. An over-temperature thermocouple is optional and highly recommended as unattended operation is likely due to the long time period needed for the crystal growing process.

If temperatures of more than 1800°C are required for Bridgman crystal growing processes, Carbolite Gero offers suitable solutions described in chapter Crystal Growth Furnaces.

Options

Depending on the requirements, several options are available for both software and hardware configurations. In principle, every tube furnace can be used as a base system for crystal growing according to the Bridgman method.

- Over-temperature protection with Eurotherm controller
- Rotary vane pump
- High vacuum pumping unit
- Chiller, if no cooling water is available
- Additional gas inlet with valve and rotameter
- Probe thermocouple, located next to the sample

Software:

Manual furnaces are operated by Eurotherm controllers in combination with a KP 300 Panel. Valves and pumps are operated by simple push buttons on the panel. For data logging purposes, iTools software and PC connectivity are available.

- Eurotherm 3508: 10 different storable programs with 500 different segments.
- Eurotherm 3508: 50 different storable programs with 500 different segments
- RS 232/485
- iTools OPTION
- Over-temperature protection option (recommended for continuous and unattended use)
- Remote control

Application Example

Bridgman type crystal growing

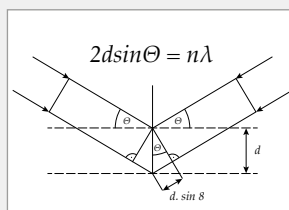

The Bridgman method is the most common and most widely used method for crystal growing. Applications range from laboratories producing small crystals to investigate physical properties to industrial applications for large single crystal manufacturing. The method is inevitable for the production of semiconductor crystals or to produce optical devices like lenses. One important example within the broad range of applications is the production of infrared sensors by Bridgman pulled CdTe / CdHgTe single crystals. Therefore, Bridgman crystal growing is a well-established method.

A crystal consists of a regular arrangement of atoms. Seven different crystal systems exist. The position of the atoms can be mathematically described. Diffraction experiments are used to discover the periodic arrangement of the atoms. For diffraction, the crystal is illuminated with coherent electromagnetic waves. The Bragg relation describes the interaction with the crystal.

Technical data

Model	T _{max} [°C]	Max. outer diameter accessory tube [mm]	Heated length [mm]	Dimensions: External H x W x D [mm]	Furnace weight [kg]	Dimensions: Control modul H x W x D [mm]	Control module weight [kg]	Power [kW]
BV-HTRV 70-250	1600, 1700, 1800	70	250	1800 x 950 x 750	300	850 x 560 x 600	60	5
BV-HTRV 100-250	1600, 1700, 1800	100	250	1800 x 950 x 750	300	850 x 560 x 600	60	6.5

On request, other tube furnaces can be mounted on the pulling device for Bridgman type crystal growth. The two most common configurations are shown.

PDS – Partial Pressure Sintering Furnace up to 1450 °C



Debinding and sintering furnace up to 1450 °C

The PDS type furnaces are available with a usable volume of 25, 120 and 250 l. With the special design of the PDS type furnaces, it is possible to do both, debinding and sintering in one furnace.

For debinding, a special gas guiding configuration and molybdenum retort are utilized to protect the heating elements from all gaseous by-products. The heating elements and radiation shields are also constructed of molybdenum. The system is surrounded by a double walled, water cooled vessel. To prevent condensation of the by-products in the gas outlet system, the tubes leading to the afterburner are heated. Debinding is normally performed at a slight overpressure, and upon request, the furnace can be configured for debinding under partial pressure. For partial pressure operation, a special oil pump is integrated into the furnace to pump the gaseous by-products out of the furnace and into the afterburner. After the debinding step, it is possible to increase the temperature up to 1450 °C for the sintering process. During sintering, a vacuum, partial pressure, or slight overpressure can be applied. The system operation is automated, and therefore, can support the use of Hydrogen up to 100% purity. A touch panel interface is used for parameter programming and process visualization. The PDS offers two operation modes. The first mode is manual operation, which consists of manually adjusting all system features. The second mode is automated and allows the user to program the operational parameters of the furnace. Upon initiating automatic operation, the system performs an evacuation step, a leakage test, and an overpressure test. Once all steps have completed successfully, the operating process begins. In the event any malfunctions are detected, the system immediately returns to a safe state, which is especially important when using reactive gases.

Various dosing and controlling devices control all gas operations. The vacuum systems are provided by various pumping stations per the required vacuum levels. The temperature in each of the three heating zones is individually controlled to achieve the best uniformity. The clear advantage of the PDS is the possibility to perform debinding and sintering in a single furnace. Careful design of the vacuum and gas flow guidance system allows the PDS to provide a single solution for the application.



PDS 120 MO/14: Partial pressure furnace with a usable volume of 120 l up to 1450 °C. The PDS is capable of debinding and sintering.

Advantages

- Debinding and sintering in one step
- Debinding in partial pressure possible
- Precisely controlled atmosphere with highest possible purity (6 N or better) for metallic furnaces
- Hydrogen partial pressure upon request
- Precisely controlled vacuum pumping speeds appropriate for use with powders
- Fully automatic operation
- Data recording for quality management

Typical applications

Debinding and sintering in one system, annealing, degassing, tempering, reduction of metallic and non metallic material, tempering, quenching, soldering, brazing, degassing, rapid prototyping, synthesis, sublimation, drying, MIM, CIM

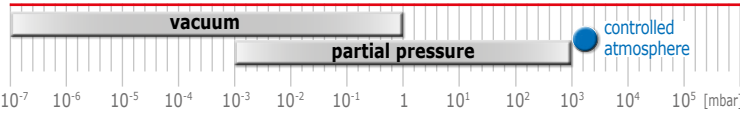

Technical details

The PDS has three heating zones. One heating zone is adapted on the furnace door. The remaining two heating zones are two heating zones at the mantle of the system. With the unique heating design, the pressure and directed gas flow provide a temperature uniformity better than ± 5 K. The heating elements are made from molybdenum. To insulate the heat, several molybdenum radiation shields are implemented. The furnace door is locked by a pneumatic valve. End switches control the doors position, opened or closed. The afterburner must be connected to propane gas and compressed air for combustion of all gaseous by-products generated during the debinding process. Upon request, a fast cooling system can be integrated into the furnace, which operates by evacuating all gas from the furnace and passing it through a heat exchanger. The heat exchanger is cooled by water and cools the gas as the heat exchanger tubes are in contact with the water cooled tubes of the vessel. The cooled gas is then pumped back into the furnace. The cooling system is a circulating, closed loop that provides expedited cooling and minimal gas consumption.

View inside



Heat exchanger to cool down the hot gas



Heated gas outlet to prevent the condensation during debinding

Application Example

Debinding and sintering



Metal injection molding (MIM) or ceramic injection molding (CIM) are net shape production processes for small parts of complex shapes that are to be produced on a large scale. Numerous methods exist for the debinding process, and a more detailed description

of the process can be found on page 62 and page 63. For both MIM and CIM, the so called "green part" consists of a powder that is mixed and shaped with a polymeric binder. With the PDS, the binder is removed by thermal debinding. Afterwards, the sintering process can be performed within the same system, which is a unique feature of the PDS furnace.

Technical data

Partial Pressure Sintering Furnace



Model

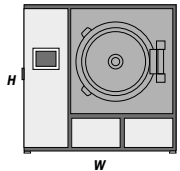

PDS 120 MO/14

External dimensions including the afterburner

H x W x D [mm]	2600 x 2300 x 3000
-----------------------	--------------------

Transport Weight

Complete system [kg]	4500
-----------------------------	------

Usable space

Volume [l]	120
H x W x D [mm]	400 x 400 x 750

Thermal values

T_{max} [°C]	1450
ΔT [K]	± 5
Cooling time [h]	8
Max. heat-up rate [K/min]	10

Connecting values

Power [kW]	230
Voltage [V]	400 (3P)
Current [A]	3 x 330
Series fuse [A]	3 x 400

Vacuum

Lakage rate [mbar l/s]	< 5 x 10 ⁻²
Vacuum range depending on the pumping unit	rough, fine or high vacuum

Cooling water required

Flow [l/min]	120
---------------------	-----

Gas supply

Nitrogen or Argon flow, others on request [l/h]	500-2000
--	----------

Controller

Controller	Siemens
-------------------	---------

In this chapter, some special furnaces are described. The metal injection molding furnaces include solutions for the whole process chain of debinding and sintering. *SERIE 3000* furnaces are based on the standard LHTG and HTK GR models, including options for pyrolysis and 3000 °C operation. At least some solutions for crystal growth as well as some customized heat treatment systems and their unique features for applications are briefly mentioned.

The shown customized furnaces are only a small amount of special solutions produced by Carbolite Gero. Please contact us in case you are in the need to perform any special heat treatment.

Working Output

SP

0.0%

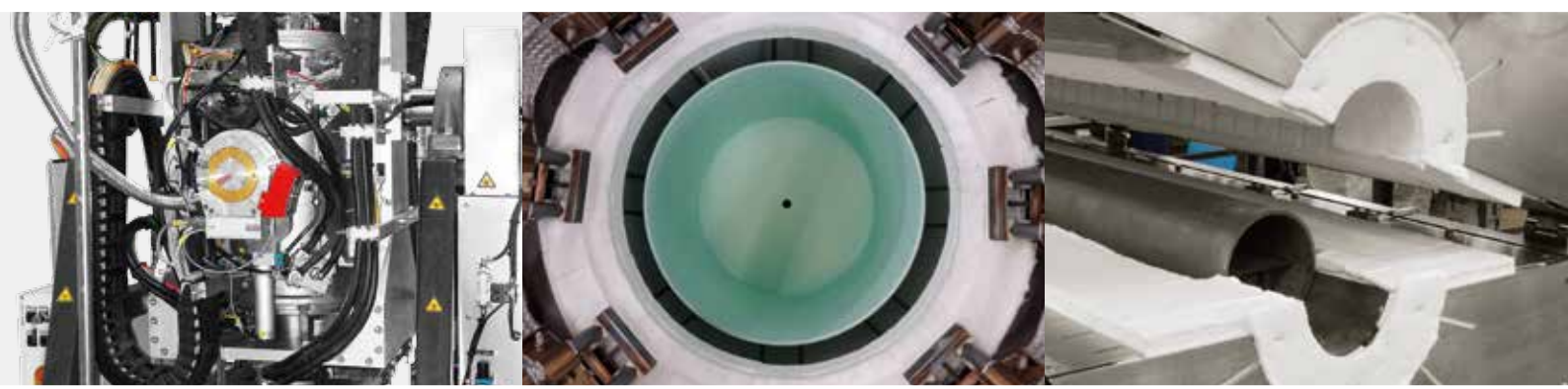

Man Op

-14.90



Special Furnaces and Options	Page
Metal Injection Moulding (MIM) Furnaces	62
Graphitization Furnaces <i>SERIE 3000</i>	64
Crystal Growth Furnaces	68
Customized Furnaces	72
Options	74

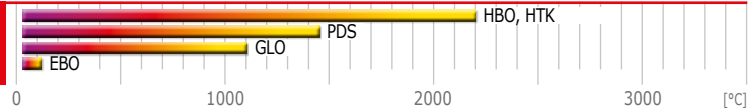

Fabrication of metal injection molding devices (MIM)



MIM (metal injection molding) is a near net-shaping process technology for the production of complex shaped devices with a high throughput. The main materials used for MIM are hard metals, stainless steels, and oxide ceramic powders

as these materials respond well to the sintering process. The MIM and CIM processes are derived from well established thermoplastic molding techniques where the use of fine metallic or ceramic powders are used instead of polymeric materials.

For MIM technology, a small amount of polymer, referred to as binder, is mixed with a metallic powder and referred to as the "feedstock". The feedstock is injected into molding cavities to form the "green part". With this technology, very complex geometries can be manufactured with high reproducibility. After shaping the "green part", the polymeric binder is removed chemically or through heat treatment. After removal of the binder, the sintering process begins. The sintering process can be performed under oxidizing, inert, or reducing atmospheres depending on the

power material used. During sintering, the parts undergo densification and shrink between 15 and 22% depending on the powder loading, material, and final density. The temperature profiles and atmosphere during debinding and sintering have to be accurately controlled to avoid distortion or formation of cracks and bubbles in the final product.

Carbolite Gero offers several debinding and sintering solutions for the MIM process. With the GLO product line, thermal debinding can be performed. The EBO systems are specifically designed and tailored for the catalytic debinding process. All gaseous by-products produced during debinding are combusted by the integrated afterburner. As a result of using the afterburner, the smell nuisance is mitigated as use of a condensate trap is not required. Sintering can be performed with the HTK, HBO, and HTBL product lines. Low pressure, vacuum, or partial pressure sintering can also be accomplished upon request. Additionally, Carbolite Gero offers PDS, partial pressure sintering furnace, that is specially designed to handle the debinding and sintering process in one complete system.

The same technology can be applied for ceramic injection molding (CIM). For both MIM and CIM applications, various feedstocks and processes exist; therefore, Carbolite Gero offers an expansive product portfolio to meet all process demands.

Debinding furnaces: EBO, GLO

GLO thermal debinding:

The GLO is a thermal debinding furnace available in usable volumes of 40, 75, 120 l. The maximum temperature is 1100 °C and is completely sealed. Prior to the thermal debinding process, the remaining Oxygen content is reduced by several cycles of vacuum evacuation and purging or by inert gas purging of the furnace chamber alone. A slight overpressure is established to define the gas flow through the furnace once heat treatment begins. The evaporating binder is guided out of the furnace by the laminar gas flow surrounding the sample material. The gaseous by-product flows through the gas outlet and combusts in the afterburner. The afterburner utilizes propane gas and compressed air. The gas outlet, leading to the afterburner, is heated in order to prevent any condensation. With the use of a high gas flow into the furnace chamber, the incoming gas is preheated in an additional heating zone to maintain the best temperature uniformities during the entire process. The GLO can also be mounted vertically (V-GLO).



GLO 40/11: Furnace with a usable volume of 40 l up to 1100°C under atmospheric pressure. The GLO is used for thermal debinding.

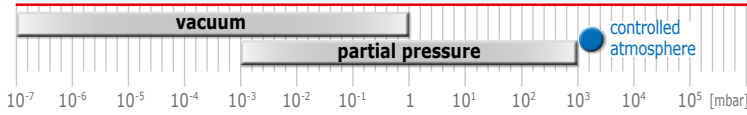

EBO catalytic debinding:

The EBO is a catalytic furnace that includes all safety provisions and automated controls for the debinding processes. The flow of nitric acid into the system creates a chemical reaction with polymeric binder, such as BASF catamold, and removes the binder from the green parts. The completion of the debinding process is automatically detected as the sensors monitoring the reaction will detect that no additional by-products are being generated by the debinding process reaction. The required process temperature is achieved by heating the vessel with water up to 150°C at most. The nitric acid tank supplied is 1 l. Larger tanks are available upon request.



EBO 120/1.5:
Debinding furnace with a usable volume of 120 l up to 150°C at most. The required working temperature is 120°C. Nitric acid is evaporated, mixed with Nitrogen and purged into the furnace for catalytic debinding.

Debinding and sintering: PDS

The PDS is capable of both, debinding and sintering. If greenparts made from BASF feedstock are catalytically debinded in an EBO, a certain amount of rest binder is still included. The PDS is capable of evaporating any remaining binder before sintering. Additionally, the PDS is capable of debinding parts containing 10% binder that were not pre-debinded beforehand.

PDS 120 Mo/14:
Partial pressure furnace with a usable volume of 120 l up to 1450°C. The PDS is capable of debinding and sintering.



The PDS design utilizes a gas guidance system for removal of gases out of the furnace. The furnace is constructed of molybdenum radiation shields and heating elements. A molybdenum retort surrounds the specimen, which ensures the specific gas flow pathway and protects the heating elements from all gaseous by-products. The debinding step can be performed at slight overpressure or partial pressure. For debinding under partial pressure, a special pump is used for guiding and removing all evaporated gases to the afterburner. The final sintering step can be performed at a maximum temperature of 1450°C. All required gas atmospheres and vacuum levels are possible during the sintering process. The PDS is available in usable volumes of 25, 120, and 200 l.



HBO 60 W/22:
Hood furnace with a usable volume of 60 l up to 2200°C and automated operation via a touch panel interface. A high vacuum pumping unit is attached to the furnace.

Sintering furnaces: HTK, HBO

The furnaces from the HTK or HBO series can all be used for sintering in various atmospheres. Samples are transferred to the sintering furnace upon completion of the debinding process. The choice between the HTK and HBO depends on practical reasons such as loading and unloading requirements. The HBO series is a metallic furnace constructed of tungsten or molybdenum. The HBO is ideal for sintering in vacuum, inert gas, or in a Hydrogen environment with the highest possible atmospheric purity. The tungsten-based furnaces are designed to achieve temperatures of 2200°C or higher upon request. The HTK has a rectangular chamber and is available in various working volumes.

HTK 25 W/22:
High temperature chamber furnace with a usable volume of 25 l up to 2200°C with automated operation via a touch panel interface.

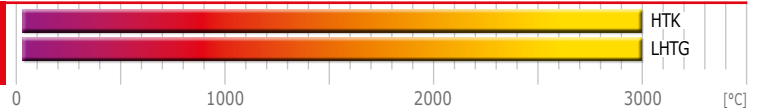

SERIE 3000 high temperature furnaces

SERIE 3000 CARBOLITE GERO

 HTK 80 GR/30: Chamber furnace from *SERIE 3000* with a usable volume of 80 l up to 3000 °C.

 LHTG 200-300/30: Laboratory furnace from *SERIE 3000* with a diameter of 200 mm and a heated length of 300 mm.

Graphitization of carbon is one of the most fundamental and important subjects for understanding carbon materials.

Because of the outstanding mechanical properties of carbon materials, the mechanism of graphitization is still a focus of research and development. Graphitization is the structural change from amorphous carbon towards crystalline graphite. Prior to graphitization, materials are pyrolyzed to create disordered (amorphous) carbon as the base material. Main structural changes occur at temperatures around 2000 °C or higher if needed. After heat treatment, the material is typically analyzed with diffraction experiments.

For this demanding heat treatment application, Carbolite Gero developed the *SERIE 3000* for heat treatment up to 3000 °C under an inert atmosphere. The *SERIE 3000* is based on the laboratory furnace LHT and on the chamber furnaces HTK, both made from graphite. The HTK or the LHT of *SERIE 3000* is equipped with an afterburner, a heated gas outlet, a retort, a special gas guiding, a sliding thermocouple and the increased power for heat treatment up to 3000 °C. It is possible to perform both pyrolysis and graphitization in a single unit. Pyrolysis occurs at lower temperatures between 400 °C and 600 °C and is controlled by a sliding thermocouple. After this step, the temperature

can be increased to a user defined value. The sliding thermocouple is automatically driven out of the hot area and a pyrometer takes over and controls the temperature. The maximum dwell time at 3000 °C for graphitization lasts only a few minutes. In this temperature range, structural changes occur within the graphite. The *SERIE 3000* systems are capable of precisely controlling and monitoring the temperature and atmosphere, which is crucial for the process. The manual version is equipped with a computer interface for the use of iTools software. The automated version logs all relevant data during the heat treatment processes at specified intervals.

All outgassing from pyrolysis is burned off by the afterburner. The afterburner is driven by propane gas and compressed air. This system requires minimal cleaning steps when compared to systems equipped with condensate traps. The heated gas outlet prevents condensation on channels leading towards the afterburner. A special design of the heating elements, insulation materials and the installation of sufficient power allows for a maximum temperature of 3000 °C.

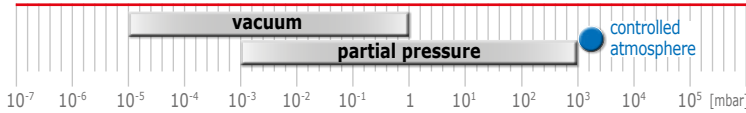

Advantages

- Temperatures up to 3000 °C
- Afterburner and heated gas outlet
- Precisely controlled vacuum pumping speeds appropriate for use with powders
- Data recording for quality management
- Retort
- Sliding thermocouple
- Pyrometer

Typical applications

Pyrolysis, siliconization, carbonisation, hardening, annealing, tempering, quenching, soldering, brazing, degassing, rapid prototyping, sintering, debinding, synthesis, sublimation, drying, MIM, CIM

Technical details

Both the LHT and HTK systems of *SERIE 3000* are equipped with graphite heating elements and insulation felt. For the highest temperature of 3000 °C, the insulation thickness and layers must be specifically designed to insulate the extreme temperatures. The system power is adapted to achieve 3000 °C with a high heating rate. At temperatures below 1000 °C, a pneumatically driven sliding thermocouple is available and allows temperature control and monitoring down to ambient temperatures. At higher temperatures, the sliding thermocouple can be used to adjust the pyrometer. The furnace is equipped with all required flanges, thermocouples, and electrical connections. The heating cassette is surrounded by a double walled, water cooled vessel. Additionally, all cabling and electrical connections are water cooled. The integrated afterburner will combust all gaseous by-products and particulates. The afterburner must be connected to an external source of compressed air and propane gas. In order to protect the heating elements, the system is equipped with a retort that utilizes a specific gas guiding flow of inert gas to purge into the vessel. As a result, a slight overpressure is generated allowing gas to enter the retort and exit through an outlet. The system processes will increase the longevity of the heating elements and alleviate the need for costly cleanings.

Software operation is available with manual or automated controls. For the manual version, all valves and pumps are operated by simple push buttons at the user panel with a rotameter used to adjust gas flow. The automated software is operated via a touch panel interface. Mass flow controllers are used to regulate the gas flow. Data logging is possible for both manual and automated operation.

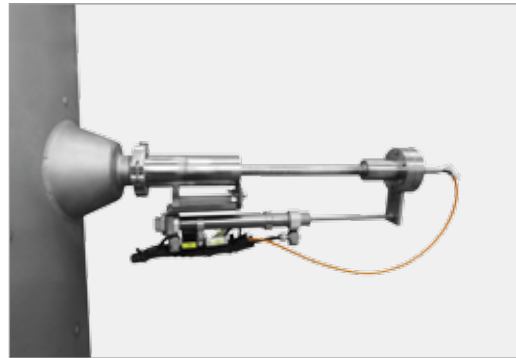

The sliding thermocouple moving into the hot area of the furnace to control and monitor temperature up to 1000 °C. At temperatures above 1000 °C, the thermocouple slides out of the furnace, and the pyrometer begins temperature measurement.



The pyrometer measures the highest temperatures up to 3000 °C. The pyrometer is focused to a specific location in the hot area. The heat radiation is transmitted through a quartz glass and measured by the pyrometer's sensor. An integrated gas tube ensures gas flow along the quartz window. The pyrometer can be adjusted by the sliding thermocouple.

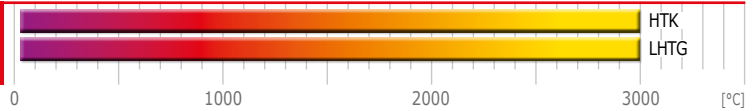

Options

For the *SERIE 3000* furnaces many options are available. Both the HTK and LHT models can be equipped with manual or automated software control.

Vacuum System:

The *SERIE 3000* furnaces are usually equipped with pre-vacuum pumps to reduce the Oxygen level prior to the heat treatment process. An Argon environment is required for heat treatment processes between 2000°C and 3000°C. Due to the high vapor pressure of graphite, vacuum heat treatment is not possible in this temperature range.

- Pre-pumps are single or double stage rotary vane pumps
- Other pumps are available on request

Software:

Software operation is available with manual or automated controls. For the manual version, all valves and pumps are operated by simple push buttons at the user panel with a rotameter used to adjust gas flow. The automated software is operated via a touch panel interface. Mass flow controllers are used to regulate the gas flow. Data logging is possible for both manual and automated operation.

- TP 1900: 20 different heat programs can be stored. Each consisting of up to 25 different segments.
- WinCC: 50 different heat programs can be stored. Each consisting of up to 30 different segments.

In manual operation two different controllers are available.

Manual furnaces are operated by Eurotherm controllers in combination with a KP 300 Panel. Valves and pumps are operated by simple push buttons on the panel. For data logging purposes, iTools software and PC connectivity are available.

- Eurotherm 3508: 10 different storable programs with 500 different segments.
- Eurotherm 3508: 50 different storable programs with 500 different segments
- RS 232/485
- iTools OPTION
- Over-temperature protection option (recommended for continuous and unattended use)
- Remote control

Water cooling:

If on-site water cooling is unavailable, a cooling system may be ordered. The cooling power will be designed to meet the requirements of the furnace and on-site power availability.

- Water cooling system: Chiller



The following furnaces are included in *SERIE 3000*:

- HTK 8 GR
- HTK 25 GR
- HTK 80 GR
- LHTG 100-200
- LHTG 200-300

Application Example

Heat treatment and analysis of graphite

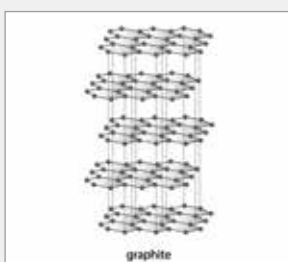

The process to control and understand graphitization is a major focus of research and development. After the heat treatment step, samples can be analyzed by a Transmission Electron Microscope (TEM); and therefore, a very thin sample slice must be prepared. Once preparation is complete, the sample is placed under the microscope and illuminated with electrons that transmit the thin sample and interact with the sample's lattice. Research has shown that the layer arrangement of graphite is significantly better with higher working temperatures during the heat treatment process. Therefore, the *SERIE 3000* furnaces are ideally suited for the application.

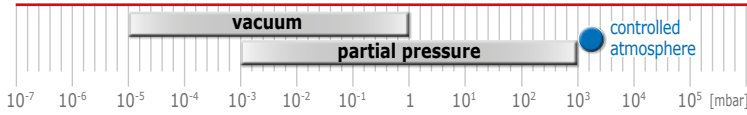

Technical data



Model

Graphite

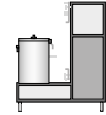
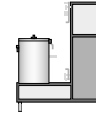
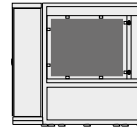

HTK 80 GR/30-1G

LHTG 100-200/30-1G

LHTG 200-300/30-1G

External dimensions

H x W x D [mm]

2500 x 2400 x 2500

1800 x 1600 x 1000

1800 x 1600 x 1000

Transport weight

Complete system [kg]

4000

1000

1500

Usable space

Volume [l]

80

1.5

9.4

H x W x D, usable space without retort [mm]

400 x 400 x 500

-

-

Ø x H, usable space without retort [mm]

-

100 x 200

200 x 300

H x W x D, usable space with retort [mm]

380 x 380 x 480

-

-

Ø x H, usable space with retort [mm]

90 x 200

180 x 300

Thermal values

T_{max} vacuum [°C]

2200

2200

2200

T_{max} atmospheric pressure [°C]

3000

3000

3000

**ΔT, between 500°C and 2200°C [K]
(according to DIN 17052)**

± 10

± 10

± 10

Max. heat-up rate [K/min]

10

20

20

Cooling time [h]

8

5

7

Connecting values

Power [kW]

250

40

85

Voltage [V]

400 (3P)

400 (3P)

400 (3P)

Current [A]

3 x 362

3 x 310

3 x 85

Series fuse [A]

3 x 400

3 x 125

3 x 100

Vacuum (option)

Leakage rate (clean, cold and empty) [mbar l/s]

< 5 x 10⁻³

Vacuum range depending on the pumping unit

rough or fine vacuum

Cooling water required

Flow [l/min]

200

30

75

Max. inlet temperature [°C]

23

23

23

Gas supply

Nitrogen or Argon flow, others on request [l/h]

200-2000

50-500

50-500

Controller

Manual operation

Eurotherm with KP 300 panel

Automatic operation

Siemens

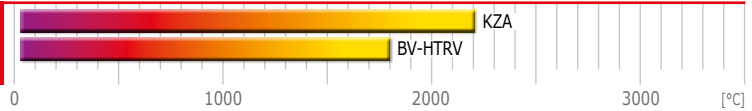

Bridgman method for crystal growing

The Bridgman method is the most common and widely used technique for crystal growing. Applications range from laboratories producing small crystals to investigate physical properties to industrial applications for large single crystal manufacturing. The method is inevitable for the production of semiconductor crystals or to produce optical devices like lenses. One important example within the broad range of applications is the production of infrared sensors by Bridgman pulled CdTe / CdHgTe single crystals. Therefore, Bridgman crystal growing is a well established method.

The physical background of the Bridgman method is to melt the material, and from which, a single crystal is grown. An element or pre-synthesized material is placed in a crucible. Quartz ampules are frequently used, which are evacuated and melted after being filled. The ampules are designed with a tip and rod or clamp in order to suspend and allow movement during the Bridgman growing process.

Carbolite Gero has experience with crystal growing devices for more than three decades. In this section, a small

summary of the different furnace variations for Bridgman type crystal growing is illustrated. The Bridgman type crystal growing method is the most common applied method. Other methods like Stockbarger type crystal growing devices have also been successfully built by Carbolite Gero. The Stockbarger method has no moving parts, and melted material is cooled down very slowly and precisely.

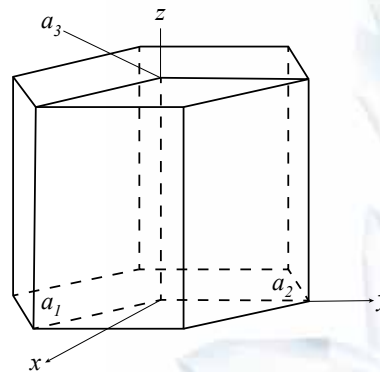

Example: The hexagonal arrangement of a crystal

Details of the Bridgman method

An ampule is inserted inside the furnace with a well defined thermal gradient. Once the ampule is positioned, the furnace heats to a temperature that melts the material inside the ampule. After a short dwelling time, the ampule is moved at a very low speed (0.1–10 mm/h) through the temperature gradient towards the lower temperature section of the furnace. During this procedure, the first crystal seeds are formed at the tip of the ampule. The largest seed further grows and dominates the growing process during further movement through the thermal gradient. The growing process can last for days, and success is dependent on a vibration-free procedure. Poor mechanical guiding or work space vibrations can prevent successful crystal growth. The success or failure of the process is only evident upon completion as the entire melt must be crystallized. Upon process completion, it is often necessary to keep the crystal at a temperature below the melting point for a final tempering step. After tempering, the ampule is carefully cooled down for removal. The crystal is then prepared for further use or analysis.

A Bridgman ampule can be inserted into the furnace in a hanging or standing orientation. The figure shows a device to hang ampules inside the furnace with the pulling device above the furnace.



The Bridgman ampule with a tip and rod is shown above. The ampule melted and closed at one side is shown in the middle. The tip serves to generate the crystal growing seed when passed through a thermal gradient. The ampule with a clamp is shown below.

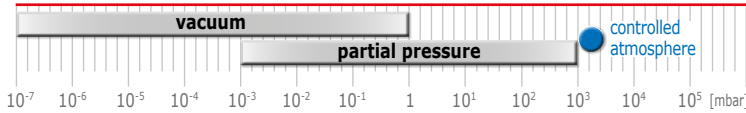

Bridgman method crystal growing tube furnaces

The vertical Bridgman device (i.e. BV-HTRV 40-500/18) is designed with a single zone high temperature tube furnace mounted at the bottom, the pulling device is mounted above the tube furnace.

The base frame can be utilized with all Carbolite Gero tube furnaces. Multi-zone tube furnaces permit a better influence on the temperature profile.

Inverse design

The vertical Bridgman device (i.e. BV-HTRV 70-250/18) is designed with a single zone tube furnace mounted at the top, the pulling device is mounted below the tube furnace.

The tube is equipped with vacuum tight flanges, and a water cooled shaft for pulling. All movements are controlled via a potentiometer. The programming controller specifies the pulling speed, and fast movement is possible.

The BV-HTRV 70-250/18 is already described in more detail on page 56 and 57. In principle, all tube furnaces can be used and modified with a pulling device for crystal growth.



BV-HTRV 70-250/18: Bridgman crystal growth furnace with a heated length of 250 mm up to 1800°C. The system is equipped with a pre-vacuum pump.

BV-HTRV 40-500/18: Bridgman crystal growth furnace with a heated length of 500 mm up to 1800°C. The pulling device is mounted above the furnace.

Bridgman method crystal growing cold wall furnaces

Modern vacuum devices for temperatures up to 2200°C can be integrated in graphite or tungsten furnaces.

The Bridgman furnace is designed for crystal growth under a high vacuum environment with the use of a turbomolecular pump. Vacuum levels of 10^{-6} are possible. The furnace is configured with three heating zones. The orientation of the furnace can be horizontal, vertical, or at defined angles between 0–90°. For the highest possible temperature gradients, an InGa bath is implemented.

KZA-V 40-400/16-1G: Bridgman crystal growth furnace with a heated length of 400 mm up to 1600°C, three zone graphite heaters for vacuum, and inert gas operation with fully automated controls and data logging.

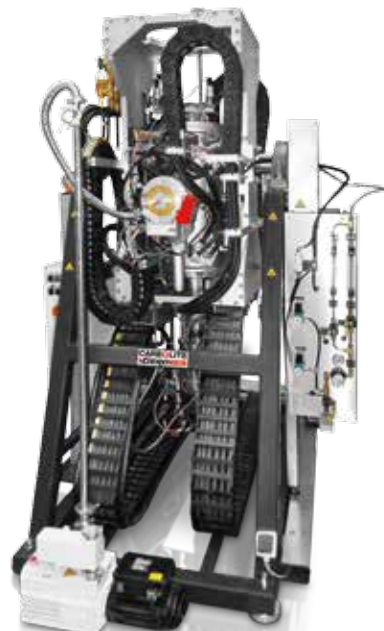

**Solutions for Bridgman-Type
 Crystal Growth**

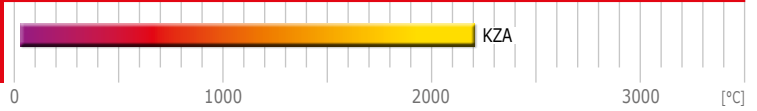

Special Bridgman growing device up to 2200°C: The samples is slowly pulled out of the hot area into an InGa bath. InGa is a liquid metal with a low vapor pressure. With this system, the highest possible temperature gradients are possible.



KZA-V 25-500/20: Bridgman crystal growth furnace with a heated length of 500 mm up to 2000°C. 4 zone graphite heaters for vacuum and inert gas operation with fully automatic control and data logging.

**Solutions for Stockbarger-Type
 Crystal Growth**

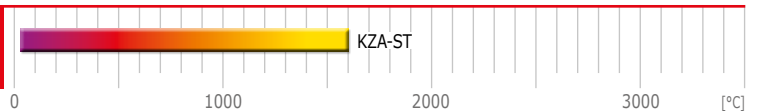

Crystal growing system for the Stockbarger method. A five zone furnace constructed of graphite whose cool down rate is precisely controlled to grow crystals.



KZA-ST 400-400/16: Stockbarger crystal growth furnace with a usable volume consisting of a 400 mm diameter and 400 mm heated length up to a maximum temperature of 1600°C.

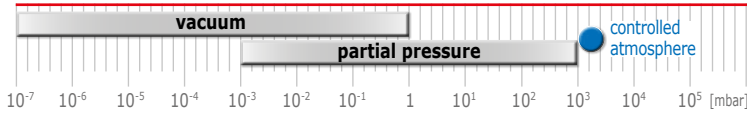

Crystal growth equipment

Carbolite Gero is specialized in the construction of furnaces and equipment for crystal growth. Company founders, Roland Geiger and Dr. Gerd Lamprecht, began their careers at the Max-Planck Institute für Festkörperforschung in Stuttgart at the crystal growth laboratory. An extensive range of crystal growth equipment and accessories can be supplied by Carbolite Gero.

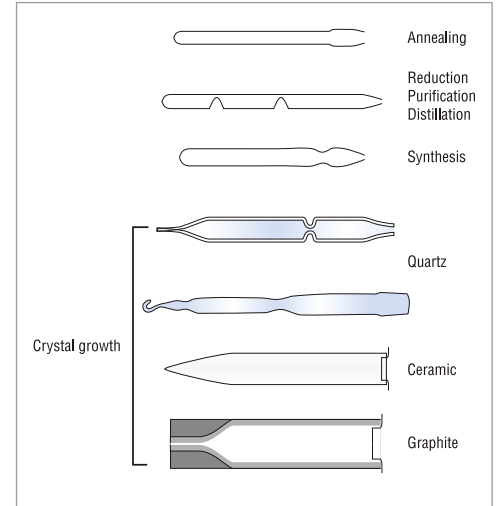

Tube types

**All tubes and crucibles available in different sizes.
Additional accessories:**

- Burners
- Wire saws
- Temperature measuring equipment
- Glass components
- Storage boxes

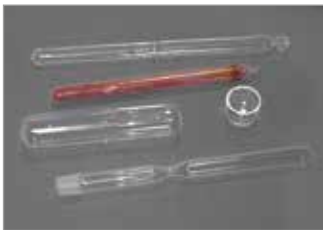

Quartz tubes for purification and synthesis



Protection tubes for operation under vacuum and protective gas



Quartz tubes for Bridgman – and growth from the vapour phase



Ceramic crucibles for Bridgman growth



Graphite crucibles for Bridgman growth



Ceramic crucible and boats for synthesis and purification



Glass-metal transition pieces for vacuum connection



Glass components for vacuum operation



Membrane containers for safe storage and transport

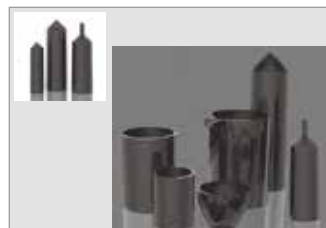

Glassy Carbon crucibles for Bridgman growth and others



Diamond wire saw for precise sample preparation



Burner for melting, graphiting and heating

Production furnace for CERN's large superconductors



Recently, a demanding special development project was carried out by Carbolite Gero in collaboration with the European Organization for Nuclear Research, CERN, located in Geneva, Switzerland. CERN is currently operating the world's largest particle accelerator,

the Large Hadron Collider (LHC). Recently, scientists at CERN confirmed the existence of the Higgs Boson, which explains the origin of the mass. This particle was only a theory of physicists before this auspicious discovery. CERN is currently studying possible upgrade scenarios for its accelerator complex. Within this so-called High Luminosity LHC (HL-LHC) project, CERN is aiming to upgrade the LHC collider after 2020-2025 in order to maintain scientific progress and exploit its full capacity. One aspect of the HiLumi LHC study concerns new high and medium field superconducting high-field dipoles (6 metres length) and high-field quadrupoles (8 metres lengths) magnets. These magnets will be able to produce magnetic fields of up to 12 Tesla. The development and production of full-scale prototypes is currently ongoing.

$$\max [|T(\vec{r}_i, t) - T(\vec{r}_j, t)|] \leq 6 \text{ K}$$

These magnets are based on Nb₃Sn superconductor which requires a reaction heat treatment with dwell times at 200°C, 400°C and 650°C. During the dwell times, the temperature uniformity inside the furnace must be within ±3°C.

To ensure proper temperature homogeneity, a reaction furnace with optimized performance was engineered. The furnace is based on high precision temperature control over multiple heating zones. In addition, inert gas ventilation components were installed to meet the required temperature homogeneity requirements and ramp times. During the acceptance tests performed at Carbolite Gero and CERN, the required temperature uniformity was achieved and measured to be better than ±3°C. Carbolite Gero also fabricated a custom loading and unloading system capable of transferring the superconducting coils and reaction supports to avoid all vibrations or shocks to the coils. The system allows fully automated operation and is currently in operation to produce coils for Nb₃Sn based prototype magnets.

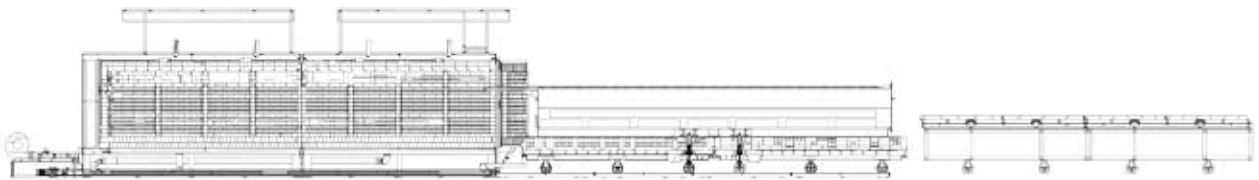

Gas tight retort with a length of 7 m for the production of superconducting coils.



Production furnace with a special loading and unloading system.

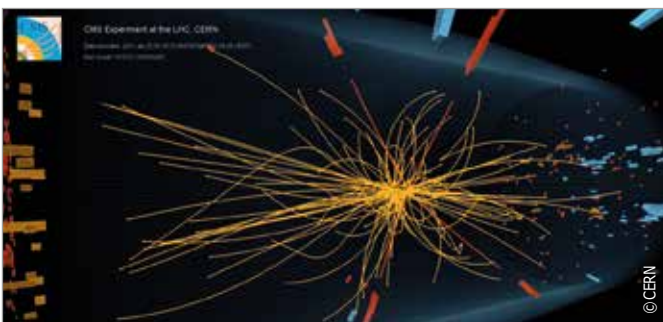

Collisions in the Large Hadron Collider (LHC).



Inside the tube, particle velocities approach the speed of light.

Operation under air and inert gas/vacuum/partial pressure in one furnace

Due to the customer requirement of a highly versatile furnace system, Carbolite Gero developed a customized solution. The furnace was designed with a usable space of 400 mm and height of 400 mm, yielding a total volume of 50 l. The base is a water cooled vessel where two heating cassettes can be integrated depending on the required application. The first cassette contains MoSi₂ heating elements that are insulated by ceramic fibre insulation. With this configuration, heat treatment processes up to 1600°C can be conducted even with 100% pure Oxygen. In total, three different gases can be mixed. The heating principle of the design can only work with Oxygen. Under vacuum or inert gas, the heating elements are not able to develop the protective Oxygen layer, and thus, is unacceptable. To overcome this obstacle, a second heating cassette was

developed and constructed with graphite. The additional graphite cassette now allows processing without the presence of Oxygen. Operating the dual cassette furnace under vacuum, slight overpressure, or partial pressure, between 10 and 1000 mbar, is now possible. For partial pressure operation, the double stage rotary vane pump is equipped with a pneumatic driven valve. In combination with the incoming gas, the pressure and gas flow can be adjusted. The system operates automatically with parameter programming, and parameters can be adjusted during operation. With a custom, vertically moving thermocouple, the temperature distribution was measured along the axis of the furnace and found to have a temperature uniformity $\pm 0.6^\circ\text{C}$.



Ceramic heating cassette



Graphite heating cassette



Whole furnace

Large F-Type Tube Furnace

5.5 m heated tube furnace up to 1000 °C

Carbolite Gero recently built a split tube furnace with a heated length of 5.5 meters and required temperature uniformity of ± 10 K. Three temperature zones were implemented and controlled in retransmission of set point mode. The tube furnace consists of CrFeAl heated element wire that is embedded into the ceramic fibre insulation of the two furnace halves. The furnace housing is cooled by ambient air convection. A work tube with a usable diameter of 120 mm can be used. To prevent the sample bending, an insert is placed into the tube, which extends the entire length of the system and supports the samples. For work tube removal, an automated system opens the furnace at the hinges.



Split tube furnace with a heated length of 5.5 meters up to 1000°C.

**Integrated Intelligence:
Measuring and Control Engineering**

Carbolite Gero offers a broad range of software and controlling options. Depending on the requirements and heat treatment processes, different controllers are available. There are many solutions, beginning with basic controllers (only one temperature can be inserted), up to large touch screens with full data logging and remote control.



Eurotherm controller 3216

With the Eurotherm controller (3216) the heat treatment consists of heating up and an adjacent dwell time.

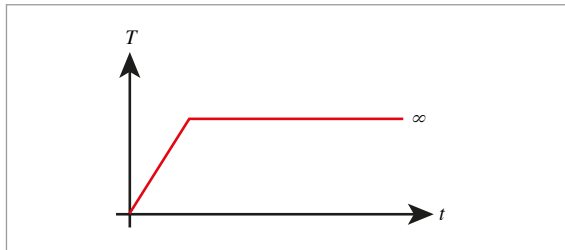

With another Eurotherm controller (3216P1), the heat treatment consists of one program with a maximum of 8 different segments. A segment can consist of a temperature increase, decrease or of a dwell time.

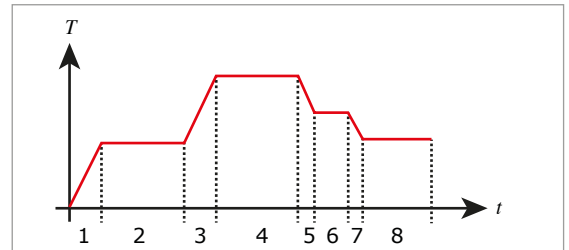

Eurotherm controller 3508

With the Eurotherm controller (3508) the heat treatment consists of one program with a maximum of 20 different segments. A segment can consist of a temperature increase, decrease, dwell time or even of a temperature jump.

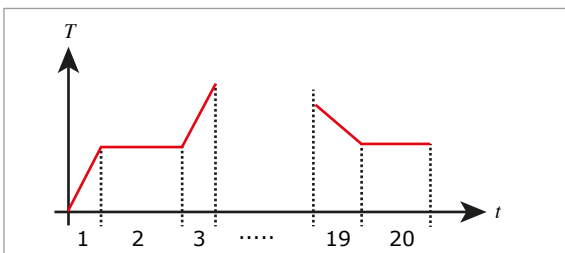

With another Eurotherm controller (3508P10), 10 unique heat treatment programs can be stored with a maximum of 50 different segments; hence, a total of 500 segments are available. A segment can consist of a temperature increase, decrease, dwell time or even of a temperature jump.

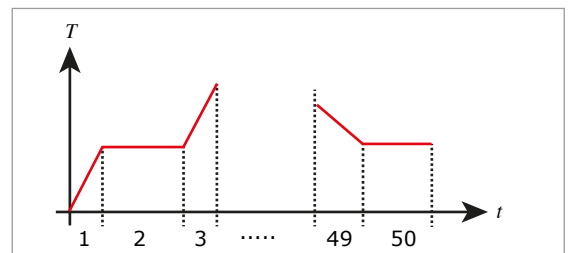

Over-temperature control 2132i

The over-temperature controller, 2132i, has a variable set point to protect either the furnace, oven or sample material. If the main controller is from the 3216 or 3508 series, the 2132 controller is integrated independently from these controllers. Over-temperature protection is strongly recommended for unattended operation or when high value or thermally sensitive materials are processed.

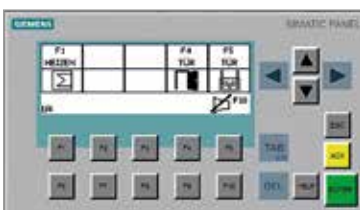

KP 300 basic

Manually operated furnaces are equipped with a KP 300 panel. With the use of touch screen buttons, the heat treatment process is started and all valves and pumps are operated. Remote operation and programming is also available. The panel is used in combination with the Eurotherm 3508 controller.



Mini 8 control unit

With the Eurotherm Mini 8 controller, 12 unique heat programs can be stored with a maximum of 16 different segments. A segment can consist of a temperature increase, decrease, dwell time, or ramp time. Pumps, mass flow controllers, and valves can be adjusted by the controller. Remote operation and programming is an available option. The Mini 8 controller is available with a color display, touch screen panel in sizes of: 4.3" or 7.5".



TP 1900 (19")

With the TP 1900 (19"), 20 unique heat treatment programs can be stored with a maximum of 25 different segments. The furnace is operated by automated programming via a touch panel interface with logging of all process and operational data. Generation of a csv file is possible for further analysis and evaluation. Remote maintenance is an available option.



WinCC control unit

With the WinCC control unit, 50 unique heat treatment programs can be stored with each program consisting of a maximum of 30 different segments. The furnace is operated by automated programming via a touch panel interface with logging of all process and operational data. Generation of a csv file is possible for further analysis and evaluation. Remote maintenance is an available option. A complete PC is included with the WinCC control unit, which provides more flexibility compared to the TP 1900 option. Lastly, a TeamViewer program can be installed into additional PCs for additional personnel to access the system.

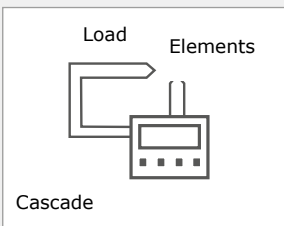

Cascade control

This feature offers the benefit of precise temperature control of the load. A standard controller operates by sensing the temperature close to the elements. With cascade control the controller's operation includes a second control thermocouple, which is used to sense the temperature of the load. It is essential that the controller is a dual loop 3508, TP 1900, Mini 8 or WinCC.

Three zone control

This has the function in 3-zone tube furnaces of extending the length of the uniform heated zone.

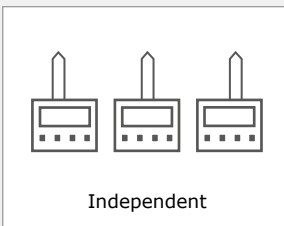

Independent control

This configuration comprises three independent controllers, each with an independent thermocouple in its respective zone. This option is not designed to create a temperature gradient.

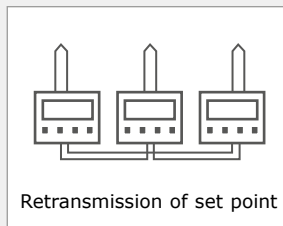

Retransmission of set point

This configuration is primarily available for 3-zone tube furnaces. A master controller is used in the middle, which operates two slave controllers.

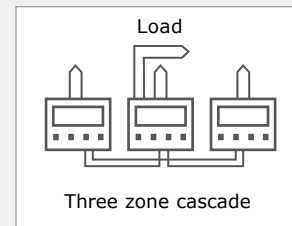

Three zone cascade control

As in single zone furnaces, cascade control allows faster heating of the furnace load and more precise control of the load temperature. A 3508, TP 1900, Win CC or Mini 8 is required.

The available options for gas handling and combustion of reactive gas or evaporated binder will influence the temperature and uniformity. All listed options are integrated with the supplied furnace. Furnace systems can also be modified at a later time to meet any new process requirements.



Retorts

Retorts made of graphite, molybdenum or tungsten serve to separate the batch from the heating chamber and can be employed for various reasons. For example, the process may make it necessary to separate the batch from the other furnace space in order to protect either the furnace from the batch or the batch from the structural materials of the furnace. It may also be necessary for pyrolyse processes to set a defined gas feed so that no pyrolyse condensation is generated in the vacuum reservoir. We manufacture appropriate retorts for all construction sizes as standard.

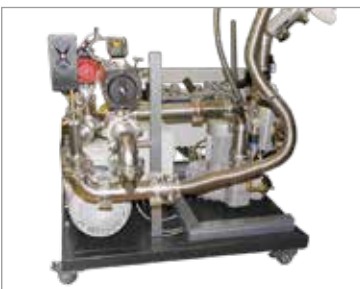

Fast cooling

The fast cooling component configuration is intended to expedite access to the furnace at process completion. The fast cooling system removes hot process gas from the unit, cools the gas via a heat exchanger, and pumps the cooled gas back into the furnace. Depending on the charge, the fast cooling components can halve the cooling time.



Dust extractor for especially dusty processes

The dust extractor extracts a large part of the dust in processes in which particles are generated and dust formed. Similar to the function of a cyclone, certain particle sizes are separated in the bottom section. A filter can protect the remaining piping from dust and soiling.



Gas supply for additional gases such as CO, H₂, He

All standard process gases can be used for heat treatment. With the use of combustible gases, automated safety systems are required to ensure safe operation and compliance with existing regulations. Gas supply regulation is managed by manual valve adjustments or use of electronic mass-flow controllers. In the event any process malfunctions occur, safeguard measures are immediately implemented. The gases are removed by evacuation and combustion or directly pumped out of the workspace. The design of the gas supply depends on the application process requirements. For example, the process gas can be metered and flowed into both the process retort and furnace chamber, and in the event a malfunction is detected, the protective gas will purge both the chamber and retort. A second scenario is to operate the furnace with the retort containing the process gas and furnace chamber containing the protective gas, thus, creating the need to only purge the retort in the event of a malfunction detection.



Safety package for combustible gases

The safety devices for combustible or toxic gases are a strict requirement to regulate the pre-pressure and gas flow of the working gas. Should a lack of gas be detected, the process is immediately interrupted, and a rinsing process is initiated. The protective gas must be stored in dedicated tanks to ensure sufficient quantities for rinsing and not be consumed during the heat treatment process. The purging tanks contain the entire rinsing amount required for the specified furnace's safety system. Toxic and combustible gases are ignited at the gas outlet in suitable combustion devices insofar as the gases in question are not halogenated.



Ancillary heating in door and rear wall for improved temperature distribution

The chamber furnaces are heated from four sides in the standard versions. A heating cage heats the floor, roof, and side walls to ensure that optimal temperature distribution and uniformity are achieved. For particularly demanding applications, the front and rear wall can be heated. Power feed lines, temperature sensors (pyrometer or thermo-sensor), and flanges must be integrated in the external sections of the furnace. The ancillary heating elements are regulated by low voltage transformers and upstream thyristors.



Vacuum pump stand for atmosphere change

Atmospheric change is required for all heat treatment processes where oxidation is unacceptable. For lower quality demands, the residual gas composition can be modified by rinsing. However, the system will never be completely free of Oxygen, and the porous insulation will wear excessively due to the reactions with Oxygen as the furnace is heated. For this reason, a simple vacuum pump should be employed in furnaces where a modified atmosphere is required. Simple evacuation and filling with protective gas will lead to a residual Oxygen level of 200–500 ppm, and can be reduced further by performing additional cycles of evacuation and flooding.



Vacuum pump stand for vacuum operation in the initial vacuum up to 5×10^{-2} mbar

Vacuum processes require lower pressure levels and high vacuum pump performance and speed. For fine vacuum levels, pre-pumps are combined with roots pumps. The combination and configuration depend on the furnace size and the process requirements.



Vacuum pump stand for high vacuum operation up to 10^{-5} mbar

For high vacuum operation, additional oil diffusion pumps or turbomolecular pumps need to be employed. The configuration and assembly of the pumping system is greatly dependent on the application. Graphite furnaces work well with optimally configured oil diffusion pumps and reach ranges in the 10^{-5} mbar. Furnaces that are not insulated with ceramic fibre can achieve vacuum levels of 10^{-6} mbar or better.



Debinding assembly with active combustion flame

Thermal debinding or pyrolysis releases gaseous hydrocarbons that eventually condense. In order to prevent condensation within the pipes to the condensation trap or combustion apparatuses, the pipes are heated. The gaseous by-products are removed from the furnace in one of two ways. The first method involves the generation of a slight overpressure in the furnace with a decreased pressure at the gas outlet. By manipulating the pressures as such, the by-products flow in a directional manner toward the gas outlet. The second method is used only for debinding at required process pressures and uses a special vacuum pump. The vacuum pump removes the gases, and a pressure regulator valve maintains the furnace pressure at a stable level. For example, the vacuum pump configuration allows debinding at 800 mbar with constant gas flow.

The gaseous by-products condense or are subject to combustion. The combustion device must be configured to handle the volume of outgassing generated, and vacuum devices must be installed on-site.



Sliding thermocouple

High temperatures are generally regulated using pyrometers. Pyrometers have a pre-defined measuring range and are employed for applications in the standard temperature ranges of 350°C–2500°C. As a heat treatment process starts, the furnace is at ambient temperature and is not detected by the pyrometer as it is lower than the defined measuring range. With sensitive sample specimens, the temperatures must be increased from ambient temperature in a regulated manner. Therefore, the use of sliding thermocouples are essential to monitor and regulate the entire process from ambient to final temperature. The sliding thermocouple will provide thermal monitoring during the process until the crossover temperature has been achieved. At the crossover point, the thermocouple will retract from the furnace, as it will become damaged otherwise, and the pyrometer begins to monitor the process temperature. Once the process is complete and the furnace begins to cool down, a crossover temperature is again reached that will trigger the thermocouple to re-insert into the furnace to regulate and monitor temperatures until the system returns to ambient temperature.



Reference pyrometer

Pyrometers are visual radiation measuring devices. In a vacuum furnace, the pyrometers must measure through a vacuum-tight window disc. When the disc becomes dirty, an inaccurate temperature reading results. For this reason, a secondary reference pyrometer can be supplied to ensure the accuracy of the monitoring pyrometer. The window disc of the reference pyrometer is protected from becoming soiled by the use of a valve that opens, for example, every 30 minutes for 30 seconds. The recorded result can be documented in the data recording system. If the measuring result in the reference pyrometer suddenly jumps, the disc of the regulating pyrometer is probably soiled and must be cleaned before the next run.

Pressure regulation 10-1000 mbar

When operating with a partial pressure of gas, the gas can be passed at a constant flow through the mass flow controller in the furnace. At the specified furnace pressure, e.g. 80 mbar, the regulating valve opens and gases are siphoned from the furnace until the target pressure is achieved. The valve will slowly close and only allow the removal of gas quantities that the mass flow controller allows into the furnace to ensure constant pressure levels. Additional pressure alterations, due to heating up and cooling down, can be precisely regulated by the valve and control system. Overpressure process can also be regulated by these components.

Configuration for higher temperatures

Graphite furnaces are generally configured for operating temperatures up to 2200°C. While higher temperatures are possible, consideration of all components is paramount in order to achieve the much higher performance demand. For example, a temperature increase from 2200°C to 2500°C is a performance increase of 25%; therefore, all components must be re-evaluated to ensure this demand can be achieved. It is also important to ensure the the cool water station performance is modified accordingly.

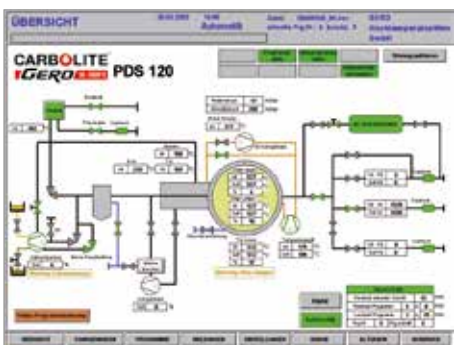

WinCC process visualization on production PC

The furnace operation and parameters can be regulated manually or automatically via an SPC. A touch panel interface is used as the standard operating interface. The WinCC process visualization operates on the production PC and provides substantial advantages over the use of the touch panel interface for recording process data and easy parameter inputs and adjustments. All relevant process parameters including power, voltage, and performance are logged at specified intervals. Batch data, special features, time, and all critical parameters are stored with the process. With the use of WinCC, the process can be programmed to start at any point in time and enables precise process analytics.



Compensation for power factor 1.0

A power compensator or filter can be integrated into the furnace to accommodate for fluctuations in the main power supply within the operating facility. The compensator or filter generates a power factor close to 1.0 and prevents feedback of reactive power.



Cooling water station for direct cooling up to 160 kW cooling capacity

If on-site water cooling is not currently available, a cooling unit can be supplied based on the furnace requirements. The cooling equipment can be installed on the outside grounds or roof of the operating facility. Higher performance units can be configured separately as required by the furnace.

Accessories for Operation under Vacuum and Process Gas

For application under vacuum or process gas, a comprehensive range of accessories are available for the standard tube furnaces (F, HTRH, HTRV). Tightly sealed, high purity Al_2O_3 and Al_2O_3/SiO_2 tube materials, water cooled stainless steel flanges, and gas supply equipment allow for thermal treatment under specified atmospheres. In such treatment processes, the gas flow can be controlled either manually, with use of a flow meter, or automatically, with the use of a mass flow controller. Complete vacuum pumping systems, rotary vane pumps, turbomolecular pumps, data recording systems, and visualization software complete the product range.

The modular system components (furnace, tube, flanges, support frame, gas supply) allow the development of comprehensive configurations to provide solutions for almost every high temperature application.

As with all Carbolite Gero products, the quality of the materials of construction is essential. In addition to manufacturing standard furnaces, development of unique, customized system solutions for ambitious, complex thermal treatment processes are possible.



Water cooled stainless steel flange



Ceramic tubes



Fibre plugs in various dimensions and materials for a maximum temperature of 1800°C

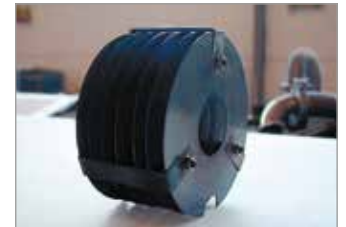

Radiation protection packaging

Tube Furnace Accessories

With the use of different tube furnace accessories, heat treatment up to 1800°C can be carried out in various conditions such as vacuum, inert, or reactive gas atmospheres. Therefore, a wide array of applications is possible.



All furnace types can be provided with protective gas equipment or vacuum/protective gas equipment. Dense, ultra-pure Al_2O_3 and Al_2O_3 / SiO_2 pipe materials, in combination with water-cooled stainless steel flanges, establish a gastight test chamber where defined atmospheres can be generated.



Upon request, tube furnaces can be supplied with a robustly welded frame with or with casters and control cabinet.



Attachment housings can be secured to the furnace for convenient vacuum / protective gas operation. It is possible to fit up to two gas supply stations to these housings.



As some furnaces can be oriented horizontally as well as vertically, an extra stand is available that is specifically designed to guarantee a safe working environment in any position.



Equipment flanges can be furnished with fast clamping seals.



For loading samples, sample boats and crucibles are available in various sizes and materials.



Vacuum pumps or complete pumping systems with the appropriate measuring technology.

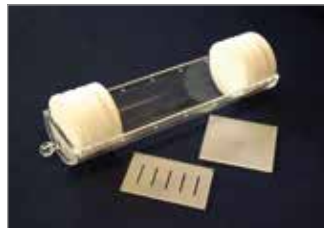

In response to customer demand, sample carriers for wafers or sample attachments of various materials are available.



A comprehensively fitted, protective gas supply on a mounting plate or as an installation component are designed for laboratory customers.

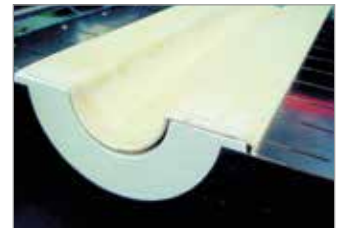

For split tube furnaces we offer robustly shaped ceramic panels to protect the heating elements and for sample holding.

Work tube end seals

The work tube end seals are required to contain a modified atmosphere and for working under vacuum. Vacuum levels of 10^{-6} mbar are possible. End seals are manufactured from stainless steel and are for use with extended work tubes only. End seals are designed to fit work tubes with the following outside diameters: 32, 46, 60, 70, 86, 100, 111, 150, and 165 mm. Additional sizes are available upon request at an added cost.

The following fittings are available for use with the end seals: blank seal, gas nozzle (inlet/outlet), vacuum flanges (NW16, NW25 or NW40) and thermocouple glands (Ø1.5 mm, 3 mm and 10 mm). Where the end seal diameter is large enough, combinations of the above fittings are possible, e.g. gas inlet/out nozzle + thermocouple gland. The end seals are designed for use in combination with insulation plugs or radiation shields. Water cooled end seals are available on request. To accommodate the additional weight of end seals, tube supports are recommended.



Gas nozzle (inlet/outlet)



NW40 vacuum flange



Thermocouple gland (1.5 mm)

Accessories and Options for Tube Furnaces

Tube Material	Used for	Maximum recommended temperature [°C] under atmospheric pressure	Maximum recommended temperature [°C] under vacuum	Maximum inner diameter [mm]	Maximum heating rate [K/h]
Aluminium Oxide (Sillimanite (Al ₂ O ₃) 530)	Tube furnaces	1500	not possible	200	600
Aluminium Oxide (Pythagoras 610)	Tube furnaces	1450	1450	100	< 300
Aluminium Oxide (Alsinth 799)	Tube furnaces	1800	1450	100	< 300
Quartz	Tube furnaces, GLO only on demand	1050	1050	like required	maximum heating rates possible
CrFeAl alloy (APM)	Tube furnaces, GLO	1250	1200	180	maximum heating rates possible
NiCr alloy (Inconel 600)	Tube furnaces, GLO	1100	750	like required	maximum heating rates possible
high temperature steel 1.4841	Tube furnaces, GLO	1100	600	like required	maximum heating rates possible

The furnaces can be equipped with different working tubes. All additional options, which can be used in combination with a work tube, are described in the chapter Options.

Index

Model	Description	Page
A		
AZ	Eight-zone Tube Furnace up to 1300 °C	24
B		
BV-HTRV	Bridgman Crystal Growth Furnaces up to 1800 °C	56
E		
EBO	Debinding Furnace up to 150 °C	14
F		
FHA	Tube Furnaces up to 1350 °C	22
FST	Split Tube Furnaces up to 1300 °C	23
G		
GLO	Annealing Furnaces up to 1100 °C	16
H		
HB	Hood Furnaces up to 1800 °C	46
HBO	Hood Furnaces up to 2200 °C	42
HTBL	Bottom Loading Furnaces up to 2200 °C	48
HTK	Chamber Furnaces up to 2200 °C	34

Model	Description	Page
HTKE	Chamber Furnaces up to 1800 °C	40
HTRH	Tube Furnaces, Horizontal up to 1800 °C	28
HTRH-H₂	Hydrogen Tube Furnace up to 1600 °C	32
HTRV	Tube Furnaces, Vertical up to 1800 °C	30
HTRV-A	Split Tube Furnaces, Vertical up to 1700 °C	31
L		
LHT	Laboratory Furnaces up to 3000 °C	52
P		
PDS	Partial Pressure Sintering Furnace up to 1450 °C	58
V		
VL	Soldering Tube Furnace up to 1050 °C	20

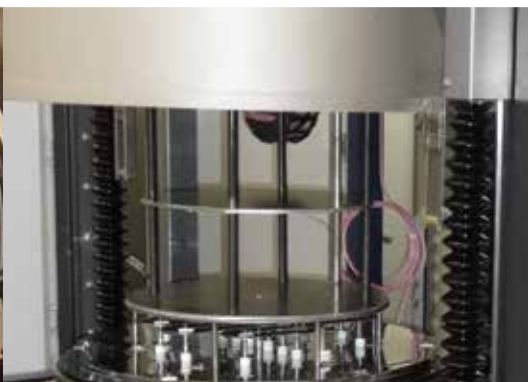

CARBOLITE[®]
IGERO 30-3000°C

CARBOLITE[®]
IGERO 30-3000°C



Carbolite Gero GmbH & Co. KG
Hesselbachstr. 15
75242 Neuhausen
Germany

Phone +49(0)7234 9522-0
Fax +49(0)7234 9522-99
E-Mail info@carbolite-gero.de
Internet www.carbolite-gero.de

Carbolite Gero Ltd.
Parsons Lane, Hope
Hope Valley, S33 6RB
UK

Phone +44(0)1433 620011
Fax +44(0)1433 621198
E-Mail info@carbolite-gero.com
Internet www.carbolite-gero.com

part of **VERDER**
scientific